

**REPORT ON THE METOD AND MEANS
UTILIZED IN CUBA
TO ELIMINATE ILLITERACY**

TABLE OF CONTENTS

Introduction	9
Message to Cuba	10
Preface	11

Part I

ANTECEDENTS OF THE LITERACY CAMPAIGN

Chapter I

— The Illiteracy Situation in Cuba	15
1. Cuba and its Population	15
2. The Illiteracy Situation in Cuba	15

Chapter II

— The First Measures Adopted by the Revolutionary Government for the Education Of School Age Children	18
1. The Urban-Rural Interrelationship	18
2. Voluntary Teachers	18

Chapter III

— The First Measures Adopted by the Revolutionary Governments for Abolishing Illiteracy Among Adults	17
1. The National Literacy and Basic Education Commission	17
2. The Work of the Commission	17
3. The First Statistics on the Work to Abolish Illiteracy (September, 1960)	17
4. Search for the Active and Passive Vocabulary of the Cuban Peasant	18

Part II

THE LITERACY CAMPAIGN

Chapter I

— The Four Stages of the Campaign ...	21
---------------------------------------	----

Chapter II

• The Technical Structure of the Campaign (Preparatory stage)	22
1. The National Literacy Commission	22
2. The Technical Department	23
a) Didactical aspect:	
◆ The Primer «We Shall Conquer» («Venceremos»)	23
◆ The Manual «Let's Teach How to Read and Write» («Alfabetizemos»)	24
◆ The Seminars	24
b) The Organization Aspect	25
c) The Statistical Aspect and the Creation of a New Department of Statistics, Evaluation and Control	25
3. The Department of Statistics, Evaluation and Control ..	25
a) Census	25
b) Questionnaires	25
c) Results	27
d) Total number of those who learned how to read and write during the great Literacy Campaign, by provinces and by urban or rural place of residence	29
e) Evaluation and Control	29
4. The Publicity Department	37
5. The Department of Finance	37
6. The Department of Publications	38

Chapter III

— The Personnel Structure of the Campaign (1st stage)	40
1. The Beginning of the Campaign	40
2. The First «Alfabetizadores»	40

a) The People's «Alfabetizadoras»	40
b) The Pilot Brigades	40
3. The Role of Certified Teachers in the Campaign	41

Chapter IV

— The Organizational Structure of the Campaign (2nd stage)	42
1. Creation of the Provincial Literacy Commissions	42
2. Role of the Mass Organizations and the Political Orientation of the Campaign	42
3. The «QUINTA» Literacy Unit	43
4. The Gerardo Benítez Brigades	43
5. The «Unión de Mujeres» Workers' Brigades	46

Chapter V

— The Final Stage of the Campaign (3rd stage)	47
1. The Final Technical and Organizational effort	47
a) The Acceleration Camps	47
b) The Revolutionary Vanguard in the Struggle Against Illiteracy	47
c) Study Courses	48
2. The First Municipality Free from Illiteracy: Melón del Sur	48
3. Cuba, Territory Free from Illiteracy	49

Part III

WORKER-FARMER EDUCATION

Chapter I

— Follow-up (Seguimiento) and Worker-Farmer Improvement (Superación Obrera y Campesina)	60
1. Follow-up and Worker-Farmer Improvement Courses	73

2. Worker-Farmer Education Courses.....	54
3. Organizational Basis of the Courses	54
4. Statistics on the Increase in the Number of Courses for the Years 1952-1963	66

Chapter II

— The Worker-Farmer Education Structure	59
1. The Worker-Farmer Education Structure	59
2. Popular Organizational plane: Mass Organizations	59
3. The Mixed Plane: Councils of Education	60
4. The Administrative and Technical Plane: The National Office of Worker-Farmer Education	63

Chapter III

— Brief description of Organizational Forms and Methodology	62
1. Courses I, II and III of Worker-Farmer Education	62
2. Home Reading Circles	62
3. Characteristic Methodological Forms	63

Chapter IV

— The Teaching Personnel in Worker-Farmer Education	66
1. The Teachers	68
2. The Training of Non-certified Teachers	68

Chapter V

— Education for Women	68
1. General Aims	68
2. Department of Schools For Women's Educational Improvement	68

Chapter VI

— The Link Between Worker-Farmer Education and Technical and Professional Training	70
1. General Aims	70
2. Minimum Vocational Training Courses	70

3. The Peoples' Schools	71
4. Workers' Preparatory College	73
Conclusions	
1. Some Observations Concerning the Literacy Campaign	72
2. Some Observations Concerning Post Literacy Adult Education	74
Appendix I	76
Appendix II	78

INTRODUCTION

At the request of the Cuban Government, a Unesco Mission, formed by Mrs. Anna Lorenzetto and Professor Karel Neyš, studied during one month the methods and means utilized in Cuba for the abolition of illiteracy as well as the post-literacy work, which is being carried out at the present to raise the school level of the great masses of workers and farmers.

The Mission remained in Cuba from February 27 to March 27, 1964, visiting schools, examining documents and conversing with all of those who lead the great epopee of our Literacy Campaign. This is the official report of the Unesco, which the Ministry of Education is pleased to publish for all peoples of the world to know.

MISSION TO CUBA

The UNESCO Mission to study the means and methods used in Cuba to eliminate illiteracy, arrived in Havana on the 27th of February, 1964, and left on March 27th of the same year. Mrs. Anna Lucrezetta and Professor Karel Neys, formed the Mission.

During its stay, the Mission endeavored to gather the greatest amount of data possible. The method of work consisted of a series of interviews, of visits to schools, institutions and libraries located throughout the territory and in the capital, and of the study of ministerial documents and reports. The interviews and visits requested were granted without delay, and the data solicited, given generously. The Mission encountered a great spirit of collaboration and hospitality.

The Mission wishes to express its sincere gratitude to all of those who kindly helped it, and particularly to those persons mentioned in the list of interviews.¹

The Mission is well aware of the fact that the brevity of time dedicated to the investigation, and the dynamic nature of the two subjects under study, that is, the Literacy Campaign and worker-farmer education, did not permit a profound and exhaustive study, one which would have been possible only in the course of a much longer period of time and with a more detailed series of investigations and analyses.

However, the Mission hopes that its work may serve as a useful basis for further studies and suggest new ideas concerning more adequate methods and means for fighting illiteracy.

P R E F A C E

The study of the means and methods used in Cuba to eliminate illiteracy is divided into three parts: the antecedents of the Campaign, the Literacy Campaign itself and the post-Campaign period, concluding with some observations.

The preparations made for the Campaign and the Campaign itself have been studied in chronological order. Actually, the organization of the Campaign and the technique employed changed with the passing of the months, improving in the course of practice. Both from the point of view of the organization and of the method used, the Mission esteemed it interesting for the aims of the study to note the most outstanding stages and aspects of the Campaign.

Nevertheless, we have treated the subject of Worker-Farmer Education from a descriptive point of view, although this work has barely left the experimental stage, because from the beginning it adopted a structure which fits into the classical picture of the post-Campaign period.

Of course, this brief exposition of facts does not constitute a history of the Literacy Campaign, and does not cover the whole panorama of adult education in Cuba.

In this study, the Mission has only tried to present some particularly interesting aspects of the means and methods used in the struggle against illiteracy in Cuba during the Campaign without overlooking the gaps which might exist. In addition, it has tried to describe in general lines the work of Worker-Farmer Education, which not only is the logical corollary of the Campaign, but also makes clear the necessity of linking the educational process to an increase in production.

PART I

**ANTECEDENTS OF THE LITERACY
CAMPAIGN**

Chapter I

THE ILLITERACY SITUATION IN CUBA

1. Cuba and its Population

Cuba has a population of 7 100 000 inhabitants, 60% of which lives in urban zones. Its territory (the main island and a series of small islands) is mountainous in its eastern part and has an area of 111 500 sq. km., divided into six provinces: Pinar del Río, Havana, Matanzas, Las Villas, Camagüey and Oriente. The climate is tropical.

The economy, which is based exclusively on agriculture, and more particularly, on the cultivation of sugar cane, is underdeveloped. However, there exists numerous mineral resources (iron, copper, nickel, etc.), which have not yet been exploited, and at the present time, oil explorations are being carried out.

The Revolutionary Government is happily transforming the Cuban economy through the nationalization of the production means, industrialization and the development of agriculture.

2. The Illiteracy Situation in Cuba

According to the census of 1899, at the end of the Cuban war for independence, 57% of the population was illiterate.

The later censuses from 1900 to 1953 gave the following results:

Census Year	Illiterates
1899	56.8%
1907	43.4%
1919	38.4%
1931	28.7%
1943	22.3%
1953	23.6%

The 1953 census was the last carried out on the island before the Revolution.

It is interesting to examine the results of this census province by province:

The State of Illiteracy in Cuba

(Source: Oficina Nacional del Censo de Población de la República de Cuba en 1953)

Provinces	Total population	Illiterate population	Proportion of total population
Oriente	1 245 870	419 576	33.3%
Camagüey	465 741	127 007	27.3%
Las Villas	777 013	192 550	24.8%
Matanzas	300 981	57 770	19.2%
Havana	1 264 666	116 260	9.2%
Pinar del Río	322 349	99 377	30.8%
	<hr style="width: 100%;"/>	<hr style="width: 100%;"/>	<hr style="width: 100%;"/>
	4 376 529	1 032 840	23.6%

The difference between the provinces is clearly seen in this comparative picture. However, the greatest difference and the most dramatic contrast was found to exist between the city and the country. According to Cuban statistical experts, the 1953 census

shows that the illiterate population (23.6%) was distributed unequally between the city and the rural zones, the illiteracy rate among the urban population being 11% and among the rural population, 41.7%.

Chapter II

THE FIRST MEASURES ADOPTED BY THE REVOLUTIONARY GOVERNMENT FOR THE EDUCATION OF SCHOOL AGE CHILDREN

1. The Urban-Rural Interrelationship

Before the Revolution, 50% of school age Cuban children (approximately 800 000) did not attend school. Only 17 000 classrooms existed and 35 000 were needed. Those children lived in rural zones, and each year swelled the ranks of illiterate adults.

The schools were located close to the highways and in easily accessible places. Therefore, it was necessary to carry education to the mountains, to the most inaccessible spots.

In 1959-1960, 582 198 pupils were enrolled in primary school. In the following year, 1960-1961, 15 000 new classrooms were created in the rural zones, and the number of pupils in elementary schools rose to 1 118 942.

2. Voluntary Teachers

At the time of the revolutionary victory, there were 9 000 unemployed teachers in

Cuba, but only a small portion of these would accept a teaching post in the rural areas. Many of them were elders, and others, who were accustomed to city life, did not feel themselves capable of facing the sacrifices which teaching involves. Then, in April, 1960, Fidel Castro made an appeal to the youth of secondary schools to teach in the country, specially in the mountains.

The first contingent of 1 600 students devoted a month to practical training for primary school teaching in the Minas del Frio Camp at the Sierra Maestra mountains, and subsequently began to teach. Another 1 000 students followed this contingent, and soon another.

With time, these youths became the first group of vanguard teachers, many of which are still working today in the most isolated regions of the rural areas.¹

¹ The new system of teacher training developed from an emergency plan into a regular plan of training. Today, the training of Cuban teachers (once 6th grade has been finished) includes one year in Minas del Frio, i. e., in the Sierra Maestra mountains where the revolutionary struggle unfolded, two years in Torres de Collantes (Elcambray mountains), and two years in Tarara, close to Havana. Thus, the teachers acquire a knowledge and experience of the life they will lead afterwards in the rural areas.

Chapter III

THE FIRST MEASURES ADOPTED BY THE REVOLUTIONARY GOVERNMENT FOR ABOLISHING ILLITERACY AMONG ADULTS

1. The National Literacy and Basic Education Commission

On the 1st of January, 1959, the Revolutionary Army entered Havana. In March of the same year, the Ministry of Education created the National Literacy and Basic Education Commission (Ministerial Resolution No. 08056), made up of the Minister of Education and 5 other members, two of which represented the National Teacher's Association and the National Association of Pedagogues.

Almost at the same time, and by virtue of the same Ministerial Resolution, Provincial and Municipal Literacy and Basic Education Commissions were set up.

On the 17th of March, Fidel Castro proclaimed the Agrarian Reform Law. Through its Department of Technical, Material and Cultural Aid, the National Institute of Agrarian Reform (INRA) helped the farmers from the very beginning in the struggle against illiteracy.

2. The Work of the Commission

The first task of the Literacy and Basic Education Commission was to organize in Havana, on April, 1959, a 15 day course for 1300 voluntary teachers, on the techniques of teaching adults how to read and write.

The ideographic method of Ana Erhegoyen, the normal words method of Maria La Soler and the Lantbach method, were studied.

At first, all three methods were employed; later only those of Lantbach and Erhegoyen. Immediately following this national course, the Provincial Literacy Commissions organized brief courses in the capitals of each province.

At that time, the newspapers, radio and television stations had not been nationalized. The Literacy Commission made agreements with the newspaper managements to insert publicity material, and with radio and TV's to present the special programs «Round Table» (Mesa Redonda) and «Meet the Press» (Auto la Prensa).

3. The First Statistics on the Work to Abolish Illiteracy (September, 1959)

Starting from September, 1959, it was possible to gather the first official statistics on the work to abolish illiteracy begun in each province. Naturally, these data were of little importance compared to those obtained later, but they were already significant if the shortness of time and the difficulties of organization of the Campaign on a national scale are taken into account:

Activities to Abolish Illiteracy in September, 1959

Province	Centers	Teachers	Pupils
Pinar del Río	155	484	3 555
Havana	208	941	4 758
Matanzas	72	171	960
Las Villas	133	516	3 225
Camagüey	218	579	4 683
Oriente	56	141	2 104
Total	841	2 832	19 075

4. Search for the Active and Passive Vocabulary of the Cuban Farmer

The struggle against illiteracy continued in 1960 under the leadership of the National Literacy and Basic Education Commission. The teacher training courses were intensified and perfected. At the suggestion of the Minister of Education, Dr. Raúl Gutiérrez¹ began an investigation of the active and passive vocabulary of the Cuban farmer, with the idea of publishing a «revolutionary primer». According to Gutiérrez, those of Kehrigoen and Lambach which had been employed until then, although technically good, did not adapt themselves to the specific motivation of the moment, of the country and of the struggle against illiteracy.

There was a need for a primer whose revolutionary and political content would not only have an adequate motivation from an historical and psychological point of view, but also would equally express this motivation in a comprehensible form and as

close as possible to the language and expressions of the Cuban farmer. A poll was taken which covered 3 000 adults over 16 years of age. The island was divided into various zones, with municipalities remaining within an urban or rural zone.

It was found that of these 3 000 adults, 360 were illiterate. The reading tests were classified from 1st to 4th grade, according to difficulties; those who failed to obtain 50% of the total number of points required in reading for the first test, were considered illiterate. At the same time, the questionnaires used, were studied, and later recorded on tape. This way, not only the language of the illiterate was captured, but also his social and political views. The investigations lasted four months, ending in the last days of November, 1960. One issue of the magazine «New Weapons» («Armas nuevas») was devoted to those who recently had learned how to read and write, and the «Information Bulletin» («Boletín de Información») carried various articles for the teachers and for the «alfabetizadores»² of the adults,

¹ Director of the Educational Extension Department.

² «Alfabetizador», one who taught how to read and write during the literacy campaign in Cuba.

PART II

THE LITERACY CAMPAIGN

Chapter I

THE FOUR STAGES OF THE CAMPAIGN

The great Literary Campaign was announced by the head of the Cuban Government, Comandante Fidel Castro, at the United Nations Assembly in September, 1960, to be officially started in Cuba on January 1st, 1961, period subsequently called «Year of Education».

However, the preparatory work was begun immediately after the speech, so that, as the Minister of Education, Armando Hart Dávalos pointed out, four stages may be distinguished in the development of the Campaign.

After a preparatory period (September,

1960 to January 1, 1961), the first stage (January to April, 1961) signaled the beginning of the Campaign itself and the creation of its organizational and technical structure; the second stage (May to September) was characterized by the total participation of the mass organization and by the establishment of political guidance in the Campaign; and finally, there was the third stage, during which, thanks to the breadth of the work carried out, it was possible to reach the final objective of the campaign a few days before the year's end, that is, by December 22, 1961.

Chapter II

THE TECHNICAL STRUCTURE OF THE CAMPAIGN (Preparatory stage)

1. The National Literacy Commission

The National Literacy and Basic Education Commission underwent a complete reorganization and took the name of «National Literacy Commission».

1. Revolutionary National Militia (MNR)
2. Young Rebels' Association (AJR)
3. Popular Socialist Party (PSP)
4. Confederation of Cuban Workers (CTC)
5. National Federation of Private Schools (FNCP)
6. National Newspapermen's Association (CNP)
7. National Federation of Sugar Workers (FNTA)
8. Cuban Women's Federation (FMC)
9. Ministry of the Revolutionary Armed Forces (MINFAR)
10. March 13th Revolutionary Directorate (DR13M)
11. Federation of Farmers' Associations (FAC)
12. July 26th Movement (M26J)
13. National Association of Pedagogues (CNP)
14. National Teachers' Association (CNM)
15. Independent Front of Free Broadcasting Stations (FIEL)
16. Confederation of Secondary School Students of Cuba (CESEC)
17. National Institute of Agrarian Reform (INRA)
18. University Students Federation (FEU)

The National Literacy Commission was organized immediately into 4 departments:

1. Technical
2. Publicity
3. Finances
4. Publications

Mario Díaz Hernández was named national coordinator of these departments.

The National Commission and the Municipal Councils of Education jointly designated qualified technical advisers and teaching personnel, called «liaison delegates» (15 to 20 persons), who acted as intermediaries

This Commission was presided over by the Minister of Education, and its members were officials of the Ministry of Education, representatives of revolutionary and mass organizations, and representatives of other Ministries:

and whose mission consisted in stimulating the activities of the Municipal Councils and in guiding them in their organization.

The Municipal Council of Education followed the same pattern of the National Commission, with representatives of the revolutionary and mass organizations of the municipalities as part of it. The Council was divided into three departments:

1. Finances
2. Technical
3. Publicity

linked together by a municipal coordinator.

In its turn, the Municipal Council of Education was divided into work subcommissions (for the *barrios* and *cuartones*)¹, in accordance with the system of the three departments — finances, technical and publicity— and under the direction of a coordinator.

In the municipal technical department were gathered the experts in charge of practical work, who (with the help of advisers) guided the reading and writing groups made up of one teacher and various illiterates.

2. The Technical Department

The Technical Department of the National Literacy Commission headed by María de los Angeles Perini, was in charge of three fundamental aspects: the didactical, technical and statistical.

On account of the great amount of work the Technical Department embraced, it was divided into various sub-departments, each with a person in charge, in this case all women:²

Technical Department
Work Commission
Seminars
Evaluation
Statistics
Publications
Documentation Center
Daily Contact

a) Didactical Aspect:

• The Primer «We Shall Conquer» (Venceremos)

Experience had shown the relative success in the use of technically good manuals which lacked the valuable motivation that simple logical gradation of difficulties in a given subject may offer.

This motivation, not just revolutionary, but typically Cuban revolutionary, was presented in the 15 lessons of the primer «We Shall Conquer».

In accordance to the compound analytical method, based on repetition and increased difficulties, the 15 lessons, followed by two or three exercises, were:

1. OEA (Organization of American States)
2. INRA (National Institute of Agrarian Reform)
3. The Cooperative Farm under the Agrarian Reform
4. The Land
5. Cuban Fishermen
6. The People's Store
7. Every Cuban, a Home Owner
8. A Healthy People in a Free Cuba
9. INIT (National Institute of Tourist Industry)
10. The Mills
11. The Revolution Wins all the Battles
12. The People at Work
13. Cuba Is Not Alone
14. The Year of Education
15. Poetry and the Alphabet

The primer's illustrations were reproductions of photographs of Cuban life after the Revolution, which took into account the theme expounded. The photograph helped to capture the most essential aspect of the motivation, since it not only served as a visual aid to the illiterate, but also helped the whole process of learning how to read and write, by solving in advance the doubts which may have arisen, by providing conversational themes, and awakening the attention.

Every effort was made to prepare the primer in the most simple and comprehensive style, not only for the illiterates' sake,

¹ "Barrio" is the administrative division of the rural territory of the municipality, and "cuartón", the division of the "barrio".

² Carmen Gómez, Matilde Serra, Juana Cruz, María Inés Carmona, Palmira Cede, Ana María Rojas, Mercedes Lugones, Alicia Ouelia.

but also for those who would teach them and who were not always certified teachers, but rather, students, workers and women without teaching experience. A prolonged study was made to provide an internal logic to the gradual progression in difficulties, which would serve as a guide to the lesson itself.

One and a half million (1 500 000) copies of the primer were printed.

• **The Manual «Let's Teach How to Read and Write» («Alfabetemos»)**

At the same time, the manual «Let's Teach How to Read and Write», to be used by the teaching personnel, prepared by the same team of technical advisers, was printed and distributed.

This manual was divided into three parts. The purpose of the first, which was of a general nature, was to guide the person in charge of teaching («Words to the 'alfabetizador' — Relationship between the points in the primer and the themes in the manual — Orientations for the 'alfabetizador's»).

The second part included a clear exposition of 24 revolutionary orientation themes:

1. The Revolution
2. Fidel is Our Leader
3. The Land is Ours
4. The Cooperative Farms
5. The Right to Housing
6. Cuba Had Riches and Was Poor
7. Nationalization
8. Industrialization
9. The Revolution Converts Army Barracks into Schools
10. Racial Discrimination
11. Friends and Enemies
12. Imperialism
13. International Trade
14. War and Peace
15. International Unity
16. Democracy
17. Workers and Farmers

18. The People, United and Alert
19. Freedom of Religion
20. Health
21. Popular Recreation
22. The Abolition of Illiteracy
23. The Revolution Wears All the Rattles
24. The Declaration of Havana

The third part was made up of a list of the words used in the manual.

• **The Seminars**

The Seminars directed by the Technical Department began during this stage of the Campaign, and continued afterwards without interruption, being carried out on the different provincial and municipal levels.

On December 15, 1960, before the printing of the primer, a Seminar was organized in Santiago de Cuba, utilizing typewritten copies, for the purpose of familiarizing the technical experts and the teaching personnel with the use of the primer. The same type of Seminar was organized later in the other provinces.

Seminars were organized to learn how to:

- take a census of illiterates
- organize a census control
- organize the practical work
- teach the alphabet

But one of the main preoccupations of the Technical Department was to attain uniformity in the work of the teams, at all levels, and to create "study groups" for this purpose.

The "study groups" created the "Saturday meetings", which grouped in each area all people who participated in the work to abolish illiteracy — teachers, technical advisers and political instructors. These meetings, which may be considered as brief seminars, took place all along the Campaign (and have continued to the present day in Cuban education). They permitted the interchange of ideas and gave answers to various difficulties; they also served as stimulating experiences and social gatherings. Each

ORGANIZATIONAL DIAGRAM OF THE NATIONAL LITERACY CAMPAIGN

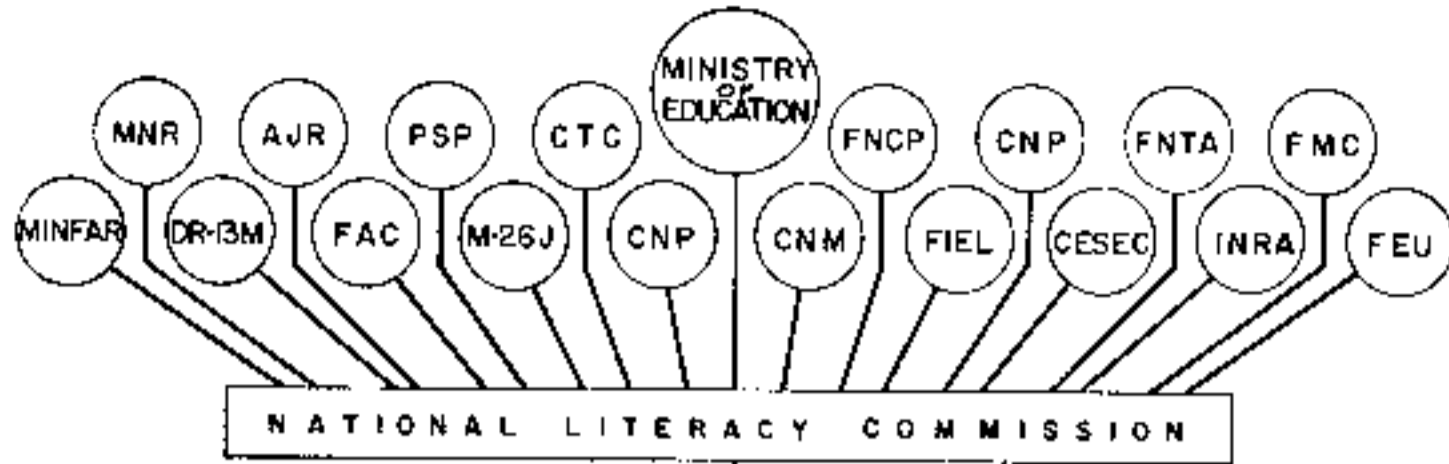

NATIONAL COORDINATION

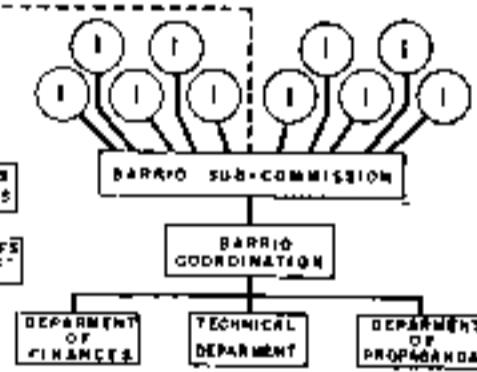
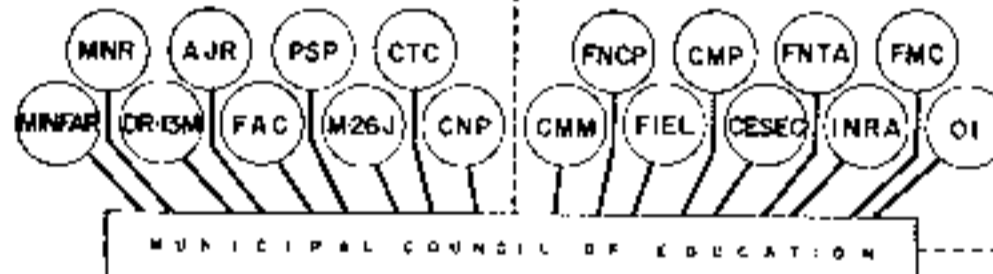
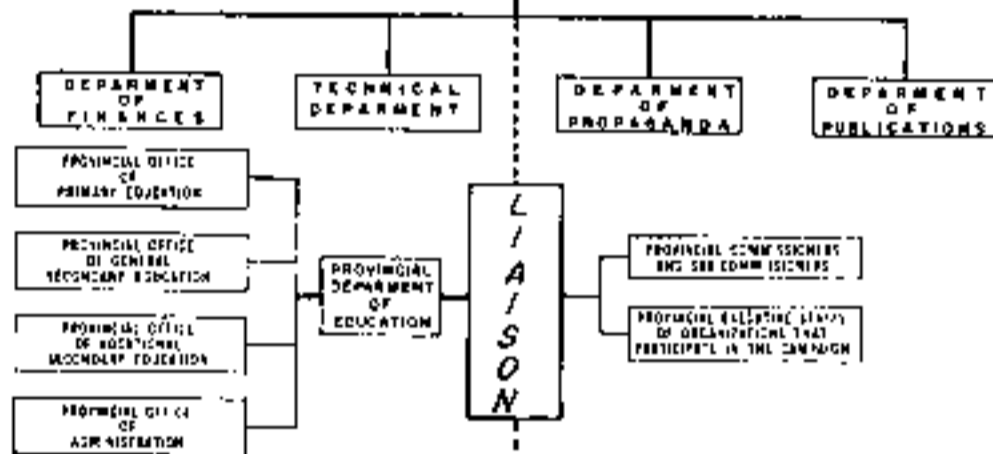

- MNR - REVOLUTIONARY NATIONAL MILITIA
- AJR - YOUNG REBELS' ASSOCIATION
- PSP - POPULAR SOCIALIST PARTY
- CTC - CONFEDERATION OF CUBAN WORKERS
- FNCP - NATIONAL FEDERATION OF PRIVATE SCHOOLS
- CNP - NATIONAL NEWSPAPERMEN'S ASSOCIATION
- FNTA - NATIONAL FEDERATION OF SUGAR WORKERS
- FMC - CUBAN WOMEN'S FEDERATION
- MINFAR - MINISTRY OF THE REVOLUTIONARY ARMED FORCES
- DR-13M - MARCH 13TH REVOLUTIONARY DIRECTORY
- FAC - FEDERATION OF FARMERS' ASSOCIATIONS
- M-26J - JULY 26TH MOVEMENT
- CNP - NATIONAL ASSOCIATION OF PEDAGOGUES
- CNM - NATIONAL TEACHERS' ASSOCIATION
- FIEL - INDEPENDENT FRONT OF FREE BROADCASTING STATIONS
- CESEC - CUBAN CONFEDERATION OF SECONDARY SCHOOL STUDENTS
- INRA - NATIONAL INSTITUTE OF AGRARIAN REFORM
- FEU - UNIVERSITY STUDENTS FEDERATION
- OI - OTHER INSTITUTIONS
- L - BARRIO INSTITUTIONS
- A - ALPHABETIZATION
- I - ILLITERATE
- ⊕ - LITERACY NUCLEUS

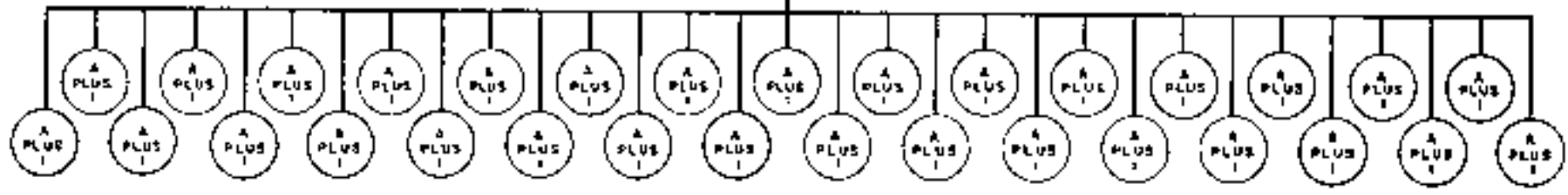
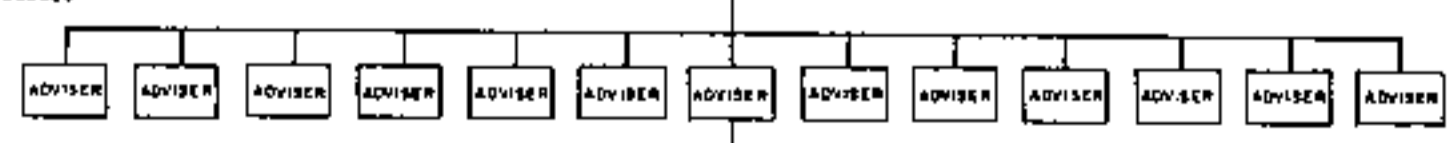
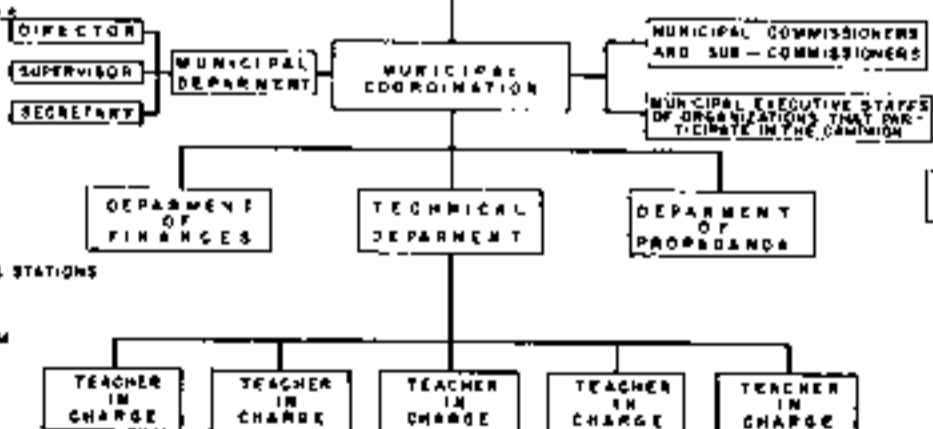

instructor reported on the work he had done up to that time, and received instructions for the following week.

b) **The Organization Aspect**

The Technical Department had the difficult task of insuring that all the instructions arrived at the remotest localities, and at the same time of directing and controlling the work. The organizational articulation of this Department was, to a certain degree, the backbone articulation of the whole Campaign organization, supported by the action of the mass organizations.

The linking plan, consistent with that of the National Literacy Commission, was the following:

(See the Organization Diagram)

c) **The Statistical Aspect and the Creation of a New Department of Statistics, Evaluation and Control**

The work of the Sub-Department of Statistics developed in three main directions. The first concerned the census and location of the illiterates; the second, the census of the "alfabetizadores" and the third, the census of those who had learned how to read.

In addition, there were other polls taken during the Campaign months: illiterates who were in the process of learning how to read and write; and instructors, those who were not teaching yet as well as those who were already teaching.

Very soon it became clear that the work was so important that the National Literacy Commission decided to convert the Sub-Department of Statistics into the Department of Statistics, Evaluation and Control.

3. **The Department of Statistics, Evaluation and Control**

a) **The census:** The initial information was taken from the 1953 population census, which gave the figure of 1 032 849 illiterates over 10 years of age.

Unlike the 1953 census, the one taken during the last months of 1960 and in 1961 was used principally for tactical purposes.

It was a census designed not only to secure information, but also, to expedite future action. For this reason, the statistics from this census were of a very practical nature.

Whenever it was possible, complicated calculations were avoided. The data from the rural and urban zones were gathered by teachers and by voluntary census takers belonging to mass organizations, on simple and easy to handle questionnaires.

b) **The Questionnaires:** Two types of questionnaires were used, both of great importance to the Campaign: one for the illiterates who had been located and the other for the "alfabetizadores".

The questionnaire for illiterates was divided into five parts:

1. Complete name, sex, age, nationality, marital status.
2. Residence and zone (i.e., rural or urban. The rural zone includes eight categories: sugar cane, tobacco, coffee, etc.)
3. Occupation, place or work, hours of work.
4. Data relative to the teaching of reading and writing: if he has attended school at any time, if he knows how to read, if he knows how to write, what hours can he study, which days of the week.
5. Data relative to the "alfabetizador" in charge of the questionnaire: Name, telephone, address, place where he taught reading and writing.

The questionnaires were filled in triplicate: 1) for the municipal, 2) for the provincial, and 3) for the national organization.

The questionnaire for the "alfabetizador" (whoever had a primary school certificate and was willing to teach an illiterate how to read and write, could be an "alfabetizador") included: questions relative to name, address, telephone, schooling, occupation, profession, and the number of hours avail-

NATIONAL LITERACY COMMISSION

Municipal Commission of

No _____

Date _____

QUESTIONNAIRE FOR ILLITERATES

I. NAME AND SURNAME:

Last _____ Middle _____ First _____
Sex: _____ Age: _____ Nationality: _____ Marital Status: _____

II. RESIDENCE AND ZONE:

Street _____ No. _____
between _____ and _____
Barrio _____ Farm _____
Municipality _____ Province _____
Zone:
Urban
Rural: Sugar cane Tobacco Coffee Livestock
Charcoal Heneguen Mining Others

III. OCCUPATION:

Present job _____
Place or work _____
Hours of work from... to.....

IV. DATA FOR THE LITERACY CAMPAIGN

Have you ever attended school? Yes No
Do you know how to read? Yes No A little
Do you know how to write? Yes No A little
Why couldn't you learn before? _____
At what time do you study? _____
On what days of the week? _____
Observations: ..

V. DATA RELATIVE TO THE "ALFABETIZADOR" IN CHARGE OF THE QUESTIONNAIRE:

Name _____ Telephone _____
Address: Street _____ No. _____ between _____ and _____
Municipality _____ Province _____
Place where you teach reading and writing _____

able for teaching. The volunteer had to indicate also whether he was willing to teach far away from his place of residence, and the places where he would prefer to teach: in a classroom, at home, in someone else's house, etc.

As said before, it was difficult to take a census of illiterates, since they tended to hide their situation, some for fear of losing their jobs, and others, unwilling to confess their ignorance. They resorted to all sorts of subterfuges, even to that of learning by memory the few paragraphs they had to read to prove their knowledge.

Only as the Campaign developed, and with the creation of a Department of Statistics covering all levels (national, provincial and municipal), but mainly, thanks to the hard and persevering work of repeatedly "screening" the same zone, inspiring and persuading, were the illiterates located, little by little.

In this work of persuasion, radio, television and newspaper publicity, the perseverance and understanding of the teaching personnel and of the investigators were of great importance.

In addition, offices, banks, court houses and post-office and telegraph branches helped considerably in the location of the illiterates. When they found that, upon receiving a document, a person could not sign his name, or when they realized that the person only knew how to sign, these agencies notified immediately the Department of Statistics. This office sent out a person to invite the illiterate to participate in the Campaign.

A check on the statistics was carried out every 15 days. The results of the national statistics on the Literacy Campaign were as follows:

c) **The results**

Number of illiterates and of "alfabetizados" in the Campaign

Illiterates		
Total	979 207	100 %
Taught	707 212	72.2%
Still illiterates	271 995	27.7%

Teaching Force

People's Instructors	120 632
"Patria o Muerte" Workers Brigades	13 616
"Comrade Benitez" Brigades	100 000*
Teachers	34 772

Total of teaching force 268 420

* It should be pointed out that 107 061 brigadistas** signed up and entered the training camp at Vateleros Beach. At the end of the Campaign in December, 1951, this figure had decreased to 89 590. This reduction in number is explained by the following:

- Many brigadistas finished their teaching before December, 1951.
- Some groups of brigadistas began to fulfill the functions of leaders in their towns and did not end the Campaign teaching personally.
- Many brigadistas were sent to technical schools, which continued functioning. These brigadistas had solicited entrance to such centers long before the Campaign.
- Some brigadistas left the Campaign due to illness.

** Brigadista: member of the Literacy Brigade

No. _____
Date _____

NATIONAL LITERACY COMMISSION
Municipal Commission of _____
QUESTIONNAIRE FOR THE "ALFABETIZADOR"

NAME:

.....
First
Middle
Last

Address
Street
Number

Barrio Finca

Municipality Province

STUDIES COMPLETED:

In Primary School

Other studies

Occupation or profession

Works at

What hours could you devote to teaching?

Are you prepared to teach away from home.

INDICATE WHERE YOU COULD TEACH:

- | | |
|---|--|
| <input type="checkbox"/> In a classroom | <input type="checkbox"/> At home |
| <input type="checkbox"/> In a center
(Cooperative, Union,
School, etc.) | <input type="checkbox"/> At someone else's house |
| | <input type="checkbox"/> In another place |

OBSERVATIONS:

.....

.....

Signature of "Alfabetizador"

d) **Total number of persons taught during the Literacy Campaign, by provinces and by rural or urban place of residence.**

<u>Province</u>	<u>In towns</u>	<u>In the country</u>	<u>Total</u>
Pinar del Rio	14 754	50 717	65 471
Havana	71 712	19 749	91 461
Matanzas	14 213	20 670	34 883
Las Villas	46 559	84 921	131 480
Camaguey	21 075	62 611	83 686
Oriente	62 739	237 487	300 226
Totals	241 057	476 155	707 212

This chart indicates by provinces, the total number of those who learned how to read and write in the urban and rural zones.

At the end of the Literacy Campaign the illiterate population was:

Total number, by provinces, of those who remained illiterate

<u>Province</u>	<u>(1961) Population</u>	<u>Illiterates</u>	<u>Percent</u>
Oriente	2 268 561	119 347	5.2
Camaguey	757 111	42 081	5.5
Las Villas	1 121 800	43 766	3.9
Matanzas	427 068	13 802	3.2
Havana	1 858 113	27 319	1.4
Pinar del Rio	500 581	25 680	5.1
Totals	6 933 253	271 995	3.9

e) **Evaluation and Control**

Evaluation and control were based on three tests: the initial, the intermediate and the final.

Each one of these tests was made according to the models appended to this report. The object of the first test was to determine whether the pupils were illiterate or semi-literate.

The pupils were considered illiterate if they knew nothing and semi-literate if they were capable of understanding the first three exercises of the test, or if they knew how to read, even though they could not write. The purpose of the intermediate test was to find out if the pupils were making progress. Each pupil took this test after finishing the exer-

cises in lesson "Cuban Fishermen" from the primer "We Shall Conquer". The final test showed whether the pupil had successfully learned the rudiments of reading and writing, and was given after finishing the primer. The reading and writing level pursued by the Campaign was that of the first grade. The pupil was considered literate when he passed the final test. Of course, he was not given anything equivalent to a first grade diploma, but he received one stating he had learned how to read and write during the Campaign. The "alfabetizador" also received a diploma, in recognition of his work.

The reading and writing course lasted, on the average, from two to three months. Nevertheless, according to the needs, it could be prolonged somewhat. These three tests,

NATIONAL LITERACY COMMISSION

THE PUPIL'S PERSONAL FILE

Complete name of pupil ...
 Age Sex Marital status
 Place of birth
 Place of residence
 Farm
 Barrio Municipality
 Province Zone
 Occupation
 Date he (she) began to study
 Date he (she) finished
 Place where taught
 Mark here the days you worked with your teacher:

(D A Y S)

MONTH	1	2	3	4	5	6	7	8	9	10	11	12	13	14	15	16	17	18	19	20	21	22	23	24	25	26	27	28	29	30	31
JANUARY																															
FEBRUARY																															
MARCH																															
APRIL																															
MAY																															
JUNE																															
JULY																															
AUGUST																															
SEPTEMBER																															
OCTOBER																															
NOVEMBER																															
DECEMBER																															

Total number of days worked

1. Why didn't he (she) learn how to read and write before?
-
-
2. Does he (she) attend classes regularly?
-
3. Is he (she) inclined to express his (her) ideas and opinions, or on the contrary, does he (she) talk little?
-
4. What does he (she) prefer:
 - Reading
 - Writing
 - Arithmetic
 - Other preferences
5. Which points in the primer interest him (her) most?
-
6. What attitude does he (she) have toward studying?
 - Interested?
 - Indifferent?
 - Reluctant?
7. Is he (she) happy in his (her) present work?
-
8. Does he (she) express a desire to improve himself (herself) through studying?
-
9. Observations
-
-
-

NATIONAL LITERACY COMMISSION
TECHNICAL DEPARTMENT
EVALUATION COMMISSION

Complete name of pupil

Address

Age Sex

Date of test

Name of "Alfabetizador"

Name of adviser

INITIAL TEST

1. Write your complete name
2. Write your address
3. Read:

loma	oso	piña
casa	dedo	fuerte
4. Dictation of these same words.
5. Read:

Toma un dedo.

Ama a Mimi.

El lee solo.
6. Dictation of the former.
7. Read:

Mañana iré a Viñales con los niños

Alquilé una cabañita. Veremos la cañada.
8. Dictation of the preceding paragraph.
9. Interpretation of the paragraph read.

NOTE: Numbers 4, 6 and 9 will be written on the reverse side of this page. On number 9, ask questions on what has been read.

NATIONAL LITERACY COMMISSION
TECHNICAL DEPARTMENT
EVALUATION COMMISSION

Complete name of pupil _____

Address _____

Age _____ Sex _____

Date on which the test is taken _____

Name of "alfabetizador" _____

Name of adviser _____

INTERMEDIATE TEST

1. Write your complete name _____

2. Write your address _____

3. Read:

pesquería	cayo	arroyo
arado	avión	fusil
palma	comer	recosa

4. Dictation of these same words.

5. Read:

Mario limpia el arma.
El sol sale por el este.
El mar está quieto.
Yara y Yumuri son ríos.

6. Dictation of the previous sentences.

7. Interpretation of the sentences read.

NOTE: Numbers 4 and 6 must be answered on the reverse side of the sheet. On number 7, ask question about the sentences read. If the pupil is unable to read a word, return to the corresponding exercise in the primer to review it.

NATIONAL LITERACY COMMISSION
TECHNICAL DEPARTMENT
EVALUATION COMMISSION

Complete name of pupil

Address

Age

Sex

Date of the test

Name of "alfabetizador"

Name of adviser

FINAL TEST

1. Write your complete name

2. Write your address

3. Read:

El Gobierno Revolucionario quiere convertir a Cuba en un país industrializado.
(The Revolutionary Government wants to convert Cuba into an industrialized country.)

Se crearán muchas industrias. Trabajarán muchos obreros. Se acabará el desempleo.
(Many industries will be created. Many workers will have jobs. Unemployment will end.)

4. Answer the following questions:

What does the Revolutionary Government want?

What will be created?

What benefits will be obtained?

5. Dictation of the paragraph read.

6. Write Dr. Fidel Castro the letter he asked for.

NOTE: Question 5 should be answered on the reverse side of this page.

The "alfabetizador" will send the letter addressed to Dr. Fidel Castro to the Municipal Council.

Fellow "alfabetizador":

Fill in the blanks clearly, preferably in print.

Do not hurry in answering the questions. The answers will come as a result of conversations with your pupil and of your observations while you work with him.

In the Observations section you are to write everything you consider of interest although not specified in the personal file.

You are to mark with an x on the time chart of the months and days of the year, the days you teach him. Leave blank the day you do not meet with him.

The number of x's will show the number of days worked.

In order to check the pupils progress, three tests are given: initial, intermediate and final.

Initial Test. Determines if the pupil is illiterate or semiliterate.

Illiterate. When the pupil is incapable of completing any of the exercises

Semi-literate. When the pupil is able to complete the first three exercises or when he knows how to read but cannot write.

Intermediate Test. Verifies if the student is making progress, if he has difficulties and what are these difficulties. This test is given after the pupil finishes all of the exercises in lesson «Cuban Fishermen».

Final Test. Decides if the pupil knows how to read and write. It is given after the pupil has finished the primer «We Shall Conquer» and is able to read any easy material.

In addition, the pupil will write a letter to Dr. Fidel Castro, which will entitle him to receive a textbook to continue his studies.

These tests are not graded, because grading does not accurately measure the progress of the pupil. The «alfabetizador» is the only one who knows how the pupil is progressing and what are his difficulties.

Because of its revolutionary quality, our Campaign is clean and honest. Your work should equal it, «alfabetizador».

as well as the letter the pupil wrote to Fidel Castro at the end of the final test (a letter which entitled him to receive a book for his future studies), were included in the personal files of the pupil and were kept in the Campaign's archives in each municipality on the island.

The pupil's personal files not only contained data concerning his studies, the days he attended school, and the results of the three tests, but also brief observations such as the following: What does he prefer—reading, writing, arithmetic? His attitude toward his studies—interested or indifferent? and finally, some key questions—Is he satisfied in his present occupation? Does he express a desire to improve himself through studying?

4. The Publicity Department

The Publicity Department, headed by Carlos Herrera, was divided into various sub-departments. The work of this Department distinguished itself by two fundamental aspects: the national mobilization for the Campaign and the organization of the Publicity departments on the provincial and municipal level.

From the beginning, the Department had three main objectives:

Above all, to persuade the illiterate population, by work on a large scale using the most diverse means: press, radio, television, celebrations, public meetings, manifestos, granting of diplomas,

In second place, through carefully planned publicity, to encourage a movement of public opinion in favor of the Campaign, in order to attract the greatest possible participation of amateur teachers.

Lastly, to give support to the work of the Technical Department, to popularize the technical orientation of the Campaign.

The Department's preparatory work lasted various months. When the Campaign offi-

cially began on January first, 1961, the whole press was already mobilized: the newspaper "Hoy" published, in daily instalments, the primer "We Shall Conquer". The other newspapers, "Revolución" and "El Mundo", carried articles and interviews almost every day, as well as daily appeals and big publicity headlines. The magazine "Bohemia" devoted many articles to the Campaign during the whole year of 1961.

In addition, the Literacy Campaign gave birth to popular songs and poems: the "Literacy Campaign Hymn", the Hymn of the "Conrado Benítez Brigades", the Hymn of the "Patria o Muerte" Workers' Brigades, the Song of the "Brigadistas of Guasuma". The author of the last two hymns mentioned, Indio Sabori, also wrote a book of poetry about the Campaign, "Primer and Lanterns" ("Cartilla y Fariol").

Other known poems were: "Despertar" ("Awaken"), by Eduardo Saborit; "La Campaña" ("The Campaign") and "Melena" by Raúl Ferrer.

In general, it can be said that the work of this Department, already considerable from the very beginning, was intensified little by little as the Campaign advanced. For example, in the months of August and September, the press devoted 30 000 articles to the Campaign.

Starting April 15, the National Radio Broadcasting gave 43 second announcements on an average of 15 times a day. The Hymn of the "Conrado Benítez" Brigades was broadcasted six times daily.

In the month of September, a three hour radio musical program with a great cast, was devoted to the Campaign.

5. The Department of Finances

It is impossible to get an idea of the cost of the Campaign, since the radio and television broadcasts and the press publicity were gratis; the "alfabetizadores" —wor-

kers, students and numerous certified teachers-- worked without remuneration. In the factories, many workers labored extra hours so that the rhythm of production would not diminish and so that their illiterate fellow workers could study.

One "alfabetizador" to two illiterates was the goal, during the last stage of the Campaign. The brigadista, isolated from his usual surroundings, was visited by his family who, if the need arose, had always and automobile at their disposal despite the scarcity of vehicles and the fact that gasoline was difficult to obtain.

Days and months were needed to win the commissions in their studying, old people not interested in learning, men and women from the towns and lying districts who did not even want to allow the "alfabetizador" in their homes.

At length however, the necessity arose for a Department of Finances. This Department administered the funds placed at the disposal of the Campaign, and had also the responsibility of collecting them. To this end, insignias and medals were awarded to the most meritorious. Social gatherings and serenades were organized.

It is therefore impossible to calculate the per capita cost of the campaign against illiteracy, because it affected everybody, including very old people, without limitations, freely, without any conjecture of what would mean an advantage or could allow the literacy drive to serve the economy and the productivity aims.

Furthermore, this aspect was subjected to criticism, both from Cuban experts and from foreign friends; but the fact remains that the Campaign was carried out in such a fashion,

It has only been possible to obtain partial data. For example: "The Literacy Campaign

in the Municipality of Havana cost 54,541.97 pesos. As for the trade union movement it contributed 16,151.89 pesos to the Campaign and the Commissions of Education in the different zones of the city gave 24,891 pesos, collected through fund drives, the sale of stickers and vignettes, and movie benefit performances. Lastly, thanks to various other fund raising methods, the costs were covered"¹

5. The Department of Publications

The Department of Publications of the National Literacy Commission worked first on the edition of the primer "We Shall Conquer", which was prepared by the Technical Commission; on the manual "Let's Teach How to Read and Write" (written by the same team); and on the arithmetic book "Produce-Save-Organize" ("Producir-Ahorran-Organizar"). This last book was distributed, especially among who recently learned how to read and write and was used as a manual during the last months of the Campaign. It was very successful, considering the interest shown by the adults in arithmetic.

As we said before, one issue of the magazine for those who had recently learned how to read and write, "New Weapon" ("Arma Nueva"), had been published in July, 1960, before the beginning of the Campaign. A second issue was published by the Ministry of the Revolutionary Armed Forces, and later a third one.

After these first three issues, eight more were published in 1962 for the "follow up". These issues contained a short summary of the basic elements of reading, brief compositions, poems and stories of a revolutionary nature which would interest those who had just learned how to read and write.

The Department published various pamphlets in order to maintain the interest of

¹ Excerpt from "Informe del Consejo Municipal de Educación, Comisión de Alfabetización", La Habana, p. 17.

certain groups of workers, for instance, woodcutters, fishermen and charcoal makers in learning how to read and write. Thus, the booklet "Culture and Work" ("La cultura y el trabajo") written by Lázaro Peña for the fishermen, encouraged them to teach the young alfabetizadores how to fish and the latter to teach the fishermen how to read.

Besides, a manual entitled "We Shall Fulfill Our Duty" - Themes on the Revolution for the Alfabetizadores ("Cumpliremos" - Temas sobre la Revolución, para los Alfabetizadores) was published for the youth of the Consejo Revolucionario Brigadas. The Department published numerous pamphlets on the important events of the Campaign, such as, the "International Seminar", the "National Literacy Congress" and the "Report to the Cuban People on the Results of the National Literacy Campaign".

During the last months of the Campaign, months of intense work on the part of the brigadistas, people's "alfabetizadores" and certified teachers, the Department published various issues of "Criollitos" devoted to the primary school children, who were being taught by improvised teachers since the beginning of the school year of 1961, for the simple reason that all of the professional teachers were working in the Campaign.

In addition, a Plan of Children's Assistance was organized with the help of members of mass organizations and Physical Education teachers, in order to keep schools open; as well as radio and TV programs for school age children. This system had the advantage of interesting the children and of giving valuable advice to the amateur teachers, who counted also with the help of the magazine "Criollitos".

The Department of Publications, attached to the Technical Department in the second stage of the Campaign, had to face many serious difficulties of a technical nature. In the first place, there was a shortage of paper and, consequently, a systematic search for it; the use of the first paper manufactured by primitive methods using sugar-cane by-products was not successful since at first the printing types slipped and left marks. In the second place, it was necessary to use the newspaper presses for school textbooks, i.e. find suitable typography, colors for the pictures, stereotype plates, reproductions, etc.

In December, 1961, at the end of the Campaign, the Department had finished its work for the Campaign proper and began a new job, the "Follow-up" (Seguimiento).

On February 21 began the publication of "New Weapon" for the "Follow-up" courses.

Chapter III

THE PERSONNEL STRUCTURE OF THE CAMPAIGN

(1st stage)

(January 1 - April 30, 1961)

1. The Beginning of the Campaign

January 1st in Cuba signaled the beginning of the Year of Education, and at the same time, the official opening of the great Literacy Campaign.

As it happens at the start of everything, the beginning of the Campaign was not easy. The census of illiterates presented many difficulties. As we have said, the illiterates tried to hide their condition and were not always willing to learn how to read and write, especially elderly people.

The local organization of the Campaign also ran into difficulties, scarcities and unexpected events. There were mountain regions very difficult to reach, and in addition for certain groups of workers, for example, fishermen and railroad workers, it was impossible to remain in one place.

Although the preparation for the Campaign was intense and painstaking, the step from the theoretical plane of the programs to the reality brought about inevitably a period of difficulties.

This said, it should be pointed out that the Campaign began with vigor and was already endowed with a good structure.

The important fact of the Cuban Campaign consists in that it was carried out by "alfabetizadores" under the guidance of professional teachers.

And this was not only because Cuba did not have a sufficient number of teachers (as we have seen, even for the primary schools it was necessary to resort to the use

of amateurs teachers), but also, and especially in this case, because the Campaign was foreseen and carried out as a great popular and revolutionary cultural movement.

"The people should teach the people", was the inspiring principle of the Campaign.

2. The First "Alfabetizadores"

a) The People's "Alfabetizadores"

The first to respond to the Campaign appeal were the People's "alfabetizadores", i.e., plain citizens, men and women determined to devote their free hours to teaching how to read and write.

Naturally, before they began to teach, and as we have said, during the course of the Campaign, periodic meetings were held in which experts and teachers gave instructions to the "alfabetizadores" through courses and brief seminars, in the "use of the primer".

As the months passed, the number of alfabetizadores increased to 120 632.

b) The Pilot Brigades

The youths belonging to the experimental brigades were also "alfabetizadores".

The Cayo Coco Brigade was the first to start working at the beginning of the Campaign. Eleven young people, boys and girls from the Pre-University Institute in Camagüey received the consent of their parents and teachers to go, on December 31, 1960, to the island of Cayo Coco located at the

Northeast of Morón (Camaguey) and inhabited by very poor charcoal makers.

On the basis of this positive experiment, brigades were formed by students who, under the guidance of a Young Rebel, a worker or a voluntary teacher, dedicated themselves to teaching how to read and write in isolated areas.

Then, the National Literacy Commission decided to authorize the closing of the schools toward the middle of April, so that the students could devote themselves to teaching how to read and write in the zones where the need was most urgent.

Thus was born the idea of the large students brigades, the Conrado Benítez Brigade, which together with the Patria o Muerte Workers' Brigade, formed a little later toward the month of August, and with the 120 632 people's "alfabetizadores", constituted the large "literacy force" of the Campaign - 233 608 "alfabetizadores" placed under the technical guidance of 34 722 professional teachers.

3. The Role of Certified Teachers in the Campaign

The 34 722 professional teachers played a role of primary importance in the Campaign. They were at the head of the Technical Departments of all the directing bodies of the Campaign, they worked as advisers to

the study nuclei, as instructors of the study circles, they devoted themselves to the most delicate of tasks, i.e. that of giving orientation to the citizen "alfabetizadores" and to the brigadistas of the Conrado Benítez and Patria o Muerte Brigades, and of instructing them in the use of the primer.

Always present at the Saturday and Sunday seminars, during the whole course of the Campaign, they endeavored to provide the "alfabetizadores" with a good technique and the love for teaching.

The Executive Committee of the National Teacher's Association began a study of what aid could be given by the secondary school teachers, urban teachers, rural teachers and voluntary teachers. It was decided that the secondary school teachers should accompany the students who formed the Conrado Benítez Brigade to the designated places; that the rural teachers work in their own school zone; that the urban teachers remain in the teachers' brigade and that the voluntary teachers work in the most inaccessible zones, helping the members of the Conrado Benítez Brigade. A large number of educators formed part of these brigades and others assumed responsibility for the Campaign in the Municipal and Provincial Councils of Education.

From a total of 36 000 teachers, 34 722 participated in the Campaign as "alfabetizadores".

Chapter IV

THE ORGANIZATIONAL STRUCTURE OF THE CAMPAIGN

(2nd stage)

(April 1 - September 5, 1961)

1. Creation of the Provincial Literacy Commissions

The second stage (from April 1 to September 5, date of the National Literacy Congress) was the most constructive of the Campaign. Naturally, the impulse had already been given, and the experience acquired had suggested measures and initiatives which were favored by the particular psychological and emotive conditions due to the Cuban events.

On account of the impetus of the Campaign in progress, the National Literacy Commission had to revise its plan of organization which, although perfect from a certain point of view, was somewhat theoretical, since the Commission had been modified in its composition, order and derivations.

Having finished their task of aid and advice to the Municipal Councils, the liaison delegates were gradually left behind by events, since Provincial Literacy Commissions were instituted with the duties of organization and orientation and as logical intermediaries between the National Literacy Commission and the Municipal Council of Education.

2. Role of the Mass Organizations and the Political Orientation of the Campaign

The mass organizations gave new impetus to the Campaign by means of an internal

process of revision or of ideological identification which led to a reorganization of the revolutionary forces in the country. The July 26th Movement and the March 13th Movement united to form the ORI (Integrated Revolutionary Organizations)* which from that time played the decisive role in the political orientation of the Campaign. At the same time, in the interval of a few months, the CDR (Committees for the Defense of the Revolution), jumping stages, had been converted into the most important mass organization, reaching into the most isolated corners of the island of Cuba.

During this whole period, representatives of the National Teachers' Association, the National Association of Pedagogues and 17 other professional associations of educators formed a commission charged with the responsibility of studying a way of entering the CTCR, side by side with the rest of the workers. There had been a law passed in 1931 which prohibited the organization of teachers and State employees into trade unions. This situation should no longer exist.

The integration of professional teachers into the Campaign was a decisive fact, thanks to which the JUCEI (Commission of Coordination, Execution and Inspection), mixed organizations, integrated with mass organizations and Party representatives as well as technicians, were set up and assumed the responsibility for the Campaign in each province and in each municipality.

* The ORI was formed by the July 26th Movement, the March 13th Movement and the People's Socialist Party (Communist). (Editors Note)

3. The "QTATA" Unit

During this period of constant renovation in the organization, and with the experience contributed by the brigades, the literacy nucleus in certain areas became a literacy unit, as the decentralization of the work grew. The professional teachers were no longer in direct charge of the illiterates, a task reserved solely to the "alfabetizadores", guided by a teacher and a political adviser.

Fifty illiterates were under the guidance of 25 "alfabetizadores", who, in turn, were counseled by an educator and a political adviser. At the top was the chief of the unit, as diagram shows.

The "Literacy Unit" established the ideal relationship of the Campaign, i.e. the horizontal relationship of one "alfabetizador" to two illiterates, 1 : 2.

As Fidel Castro emphasized, this was the objective the Campaign should pursue, objective summed up in the militant formula "QTATA", i.e. "que todo analfabeto tenga alfabetizador, que todo alfabetizador tenga analfabeto" (to every illiterate, an "alfabetizador"; to every "alfabetizador", an illiterate). The poster showing this formula clearly expressed the idea of human, social and racial integration which inspired it, a double handshake: one white arm and one black arm, one black arm and one white arm,

Thanks to the work of the brigadistas and of the "Revolutionary Vanguard in the Struggle for the Abolition of Illiteracy", this formula became a reality during the last months of the Campaign.

4. The Conrado Benítez Brigades

The history of the Conrado Benítez Brigades began on April 15, with the closing of the school year.

On April 15, the first buses with the first contingent of 2,000 youths (1,000 boys and 1,000 girls), after completing a rather exciting trip, arrived in Varadero, the place chosen for the week-long seminars designed to instruct the students in the methods of teaching, reading and writing.

By April 22, there were already 7,220 youths in Varadero: 3,905 girls and 3,315 boys.

By April 30, 11,783 (6,040 girls and 5,463 boys) had received their one week's instruction, and from this date 5,655 of them (3,040 girls and 2,615 boys) were ready as brigadistas to reach the places they had been assigned to: 1,560 in Las Villas Province, 225 in Camagüey Province and 4,870 in the province of Oriente.

By the 31 of August, when the camp was officially closed in Varadero, 105,664 youths (51,874 girls and 53,711 boys) had become brigadistas. Their distribution by province of origin was the following:

LITERACY UNITS

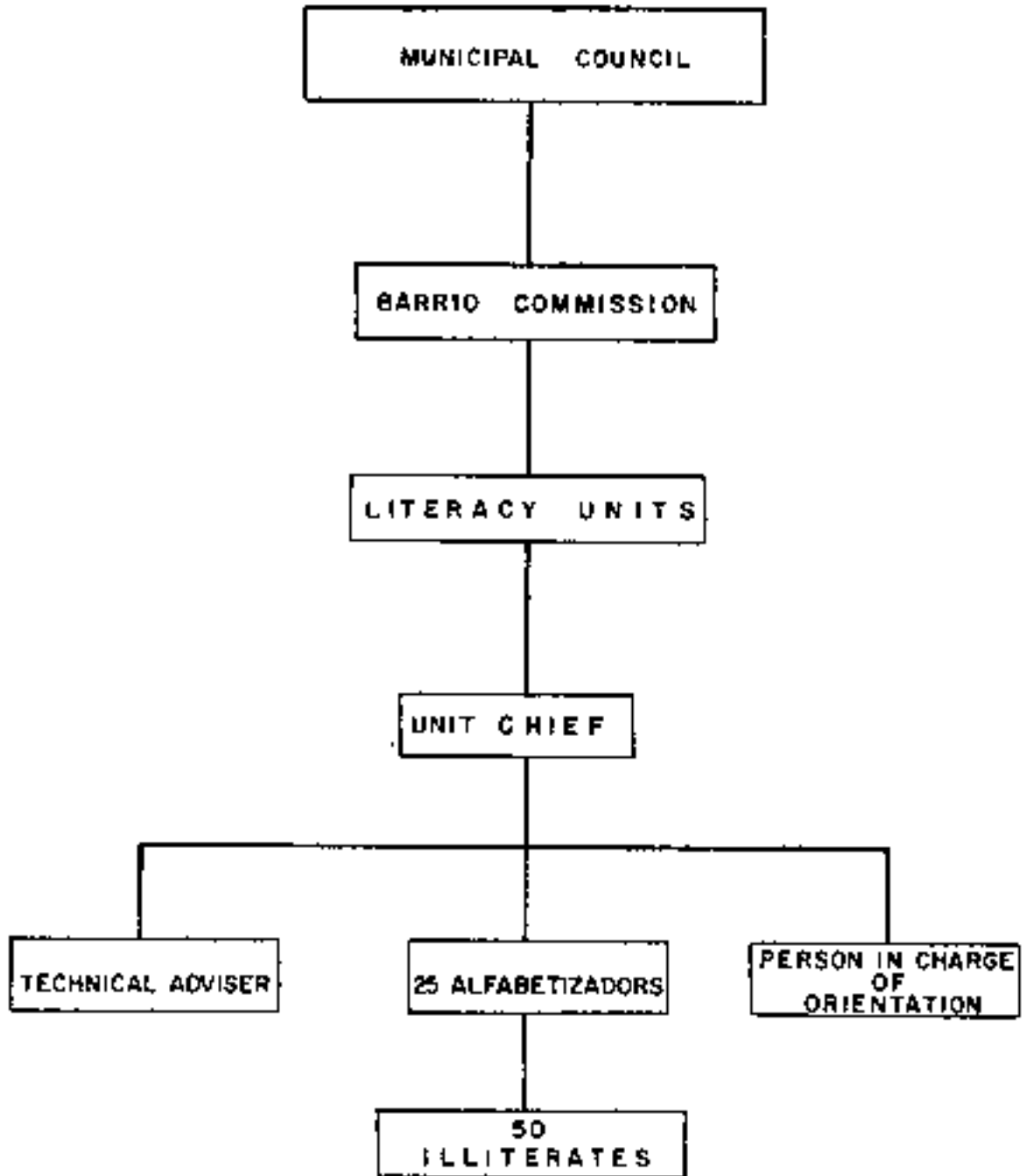

TOTAL NUMBER OF CONRADO BENITEZ BRIGADISTAS, BY PROVINCES OF ORIGIN AND BY SEX

<u>Province</u>	<u>Girls</u>	<u>Boys</u>	<u>Total</u>
Pinar del Rio	2 474	2 029	4 503
Havana	19 658	17 015	36 673
Matanzas	2 401	2 670	5 071
Las Villas	8 730	8 064	16 794
Camagüey	4 825	5 040	9 865
Oriente	15 865	15 893	32 758
	<hr/>	<hr/>	<hr/>
	54 953	50 711	105 664

After attending the course in Varadero, the brigadista did not return to his city or province, but instead went where the need was the greatest.

It can be seen that the Province of Havana provided the largest number of brigadistas, while the Province of Oriente received the largest, according to the following chart:

DESTINATION OF THE CONRADO BENITEZ BRIGADISTAS BY PROVINCES

<u>Province</u>	<u>Girls</u>	<u>Boys</u>	<u>Total</u>
Pinar del Rio	4 812	3 446	8 258
Havana	1 819	1 061	2 880
Matanzas	1 972	1 481	3 453
Las Villas	7 579	7 101	14 680
Camagüey	5 494	5 325	10 819
Oriente	33 277	32 297	65 574
	<hr/>	<hr/>	<hr/>
	54 953	50 711	105 664

As we have already seen, 69,500 of these youths worked until the end of the Campaign; 5,000 of them finished their work before. The rest, i.e. approximately 5% had to withdraw due to sickness and other motives.

The age average for the brigadistas was 14 to 16 years, but some were younger and others a little older. Their school procedure was as follows: 52% came from primary school, 32% from secondary, 5% from pre-university, 2% from commercial school, 2% from the universities, plus a 3% of primary school teachers.

Before the Campaign ended, each youth received from the National Commission a questionnaire (32 questions), to be answered at the place they were teaching.

In addition to his complete name, the brigadista had to furnish two types of information: in the first place, facts relative to the conditions, surroundings, food available and agriculture of the locality in which he taught; in the second place, information relative to his future: Would he be interested in obtaining a scholarship and studying at the expense of the State? Would he like to become a teacher? Would he like to

study another career? If so, which? Approximately 70% of the brigadistas from the Comrado Benitez Brigades obtained scholarships.

5. The Patria o Muerte Workers' Brigades

The workers organized in the CTC were present in all the leading bodies of the Campaign, from the National Commission to the Campaign, from the National Commission to those of the quarter.

In order to ease the participation of the workers in the Campaign, "Literacy Drive Committees" were constituted in the factories and work centers. These committees had various responsibilities in the work of the Campaign.

They were responsible for taking a census of the illiterates in the factory or place of work, and for signing up the voluntary "alfabetizadores", as well as for organizing the literacy work of both the illiterates and the "alfabetizadores". To this effect, they organized meetings, general assemblies, "quick meetings" or seminars of longer duration, collected money from the workers, produced didactic materials and employed all available publicity media: radio, television, posters, leaflets and manifestos.

In some factories, the workers contributed a certain percent of their daily wages, in a few, a whole day's pay was devoted to the Campaign funds.

In August, at a meeting organized by the CTC, Fidel Castro made an appeal to the workers, asking them to partake in the literacy drive.

Thirty thousand workers responded and offered to teach in the rural zones. Thus the Patria o Muerte Workers' Literacy Brigades' Brigades were born.

Brief seminars were organized to train the worker-brigadistas in the use of the primer and of the manual. At the end of the seminar, each worker-brigadista received a certificate accrediting him with having attended regularly.

According to the statistics, in September, 1961, there were 21 266 brigadistas working in the country and in the mountains. Some of them were later reintegrated in the factories in order to increase production.

At the end of the Campaign, the Patria o Muerte brigadistas paraded side by side with the Comrado Benitez brigadistas in the mass meeting at the José Martí Plaza of the Revolution on December 22, where Cuba was declared "territory free from illiteracy".

Chapter V

THE FINAL STAGE OF THE CAMPAIGN

(3rd stage)

(September 5-December 22, 1961)

1. The Final Technical and Organizational Effort

All of the instructors in the Yaguajay Camp, the members of the National Commission, of the Provincial Commissions and of the Municipal Commissions were "on a war footing" in order to give an efficient orientation to the Campaign, insuring a working connection between the Ministry of Education and the literacy units, and at the same time, that the efforts, results and competition multiply.

The third stage of the Campaign was extraordinarily brief, not only in terms of time but also in terms of the impetus and intensity of the work.

The National Literacy Congress (September 2-5, 1961) had greatly stimulated the work, clearing up certain points and determining the duties and responsibilities.

The activity was intensified. The slogan for this period was: more hours of work (the alfabetizadores prolonged their working hours), more control (they intensified the check on the pupil's attendance). For this purpose, statistic cards and information sheets were created and used until the end of the Campaign.

In addition, new techniques and forms were developed in order to accelerate the Campaign and to strengthen the teaching: the acceleration camps, the "Revolutionary Vanguard in the Struggle Against Illiteracy" and the study coaches.

a) The Acceleration Camps

The first of these camps was established in Melena del Sur, province of Havana. As it has already been indicated, Melena had experience in this work, since in 1959 after the victory of the Revolution, one of the first camps for illiterate soldiers of the Rebel Army, operated there.

The members of Melena's Municipal Council of Education thought of organizing a new camp where all of those who had fallen behind in the study of the primer could be grouped together. The camp operated a full workday. Teachers, brigadistas, experienced people's "alfabetizadores", all taught intensive classes to workers and farmers, while their fellow workers, members of the Committees for the Defense of the Revolution and of other mass organizations, replaced them at their regular jobs.

Immediately throughout the island, in each municipality, other camps came into being, organized with the collaboration of the Cuban Women's Federation, Young Rebels' Association, Small Farmers', and the Committees for the Defense of the Revolution.

b) The Revolutionary Vanguard in the Struggle Against Illiteracy

In order to attain the participation of the large contingent of State employees, private employees and all citizens desirous of co-operating in the Campaign, numerous

groups of "alfabetizadores" called "Revolutionary Vanguard in the Struggle Against Illiteracy" were formed during this period in the province of Havana, and were under the guidance of professional teachers.

By means of special automobile service, these groups were transferred from the heart of the city to the remotest zones and ties included work in the slums of Havana, where in July and August, the existence of a great number of illiterates had been discovered: El Moro, Las Yaguas, Fraternidad, Calvario, Puerto, Casa Blanca, Mantilla, La Lira, La Esperanza, Los Pinos, Miraflores.

c) Study Coaches

In November, 1961, the Provincial Commission of Havana verified that, due perhaps to the numerous collateral tasks which had to be carried out, the Campaign had fallen behind in some municipalities in the interior of the province. In accordance with the Provincial Office of the Integrated Revolutionary Organizations (O.R.I.), the «Study Coaches» were created.

Hundreds of worker «alfabetizadores» were trained in the use of the primer «We Shall Conquer» and of the manual «Let's Teach How to Read and Write», by means of an accelerated course which was organized in the National Capitol, under the

direction of the Havana Municipal Council of Education.

Upon receiving this training, these «alfabetizadores» traveled at their own expense to the interior districts of the province to start teaching.

These study coaches worked in Aguacate, Madruga, Jaruco, Güira de Melena, San Nicolas, Bauta, Caimito, Güines and other municipalities. Not only did they devote themselves to the teaching of reading and writing, but also established close social and political ties with their pupils.

2. The First Municipality Free from Illiteracy: Melena del Sur

On November 5, 1961, that is, almost two months before the official closing of the Campaign, the municipality of Melena del Sur in the province of Havana was declared the «first territory of Cuba free from illiteracy».

The results of the initial, intermediate and final tests, as well as the letter addressed to Fidel Castro from the last of the 2 269 illiterates in Melena, had already been sent or filed in the official archives. These documents belonged to history.

Fidel Castro proclaimed the results of the local Campaign to an overflowing crowd in the Melena del Sur Plaza.

STRUGGLE AGAINST ILLITERACY RESULTS IN MELENA DEL SUR

Total participation	2 868	100%
Attending school	0 000	0%
Taught	2 269	79.11%
Still illiterates	412	14.36%
Transferred	61	2.12%
Deaths	23	0.80%
Incapable of learning	103	3.59%
		<hr/>
		99.98% (1)

(1) From the «Informe de Melena del Sur».

3. Cuba, Territory Free from Illiteracy

From this moment on, each municipality made feverish efforts to finish before the others. The teachers, brigadistas and *salsa*

San Antonio de las Vegas
Santa María del Rosario
San José de las Lajas
Alquízar
San Juan de las Yeras
San Luis
Gibara
Jatibonico
San Juan y Martínez
Abreus
Carlos Rojas

and later, one after another, all of the municipalities in Cuba.

As each declaration was made, the advisers, organizers and brigadistas of the municipalities free from illiteracy passed on to the municipalities which were lagging due to serious difficulties.

Finally, December 22 arrived, day on which, in the immense José Martí Plaza of

Hetizanduresa competed in teaching more rapidly, and the illiterates competed in learning more rapidly, so that a short time later, the following municipalities could also declare themselves free from illiteracy:

-- Province of Havana
-- Province of Havana
-- Province of Havana
-- Province of Havana
-- Province of Las Villas
-- Province of Oriente
-- Province of Oriente
-- Province of Camagüey
-- Province of Pinar del Río
-- Province of Las Villas
-- Province of Matanzas

Havana and in the presence of the President of the Republic of Cuba, Osvaldo Dorticos Torrado, of the Prime Minister, Comandante Fidel Castro, of the whole Government body and of representatives of the diplomatic corps, Cuba was solemnly declared territory free from illiteracy.

The great Campaign had ended. The follow-up and worker-farmer education period began in Cuba.

PART III

WORKER-FARMER EDUCATION

Chapter I

FOLLOW-UP (SEGUIMIENTO) AND WORKER-FARMER IMPROVEMENT (SUPERACION OBRERA Y CAMPESINA)

1. Follow-up and Worker-Farmer Improvement Courses

On February 21, 1962, the first follow-up courses started.

As in the Literacy Campaign, this date signals more a point of arrival than a point of departure.

On December 27, 1961, when the great Campaign had scarcely ended, a brief course had been organized already to train the teaching personnel how to handle the technical problems of the follow-up courses on the national and provincial levels.

The whole month of January, 1962, had been devoted to intensive organization and planning of the work.

The Ministry of Education had created the Department of Worker-Farmer Education¹ and had organized the provincial offices and municipal commissions.

Many meetings had been devoted to the problems of follow-up, and various agreements had been made with the mass organizations, trade unions and the representatives of the other interested Ministries, in particular with the Ministry of Industry, the Ministry of the Armed Forces and the Institute of Agrarian Reform, concerning collaboration, coordination and aid.

In respect to the planning and organization of the classes, in January, 1962, eight

municipalities were chosen in which the first follow-up courses of an experimental nature were begun on the 29th of the same month. Thus, when the regular follow-up courses began on February 21, the ministerial organization and the collaboration of the mass organizations and trade unions was already a reality. Besides, the minimum of experience acquired in the pilot municipalities showed the desirability of planning the courses in two stages: the first level is cover the necessities consequent to the Literacy Campaign, during the period between February 21 and July 16, and the second level, that is, the follow-up classes proper from August 1 to December 20.

In June, 1962, the adult evening courses became the responsibility of the National Office of Worker-Farmer Education. Night schools were the only form of adult education known before the Revolution. They operated only in the cities and, in general, those who attended were youths interested in typing, shorthand and bookkeeping. During 1959-1960, there were 304 schools of this type in operation with 1,489 teachers and 27,456 pupils.

When the night schools became the responsibility of the National Office of Worker-Farmer Education, they underwent a gradual change and were oriented and integrated in the system and style of the worker-farmer popular education.

¹ The Post-Literacy Adult Education National Office was called Worker-Farmer Education National Office. The courses took the denomination of "follow-up" (seguimiento), which later became the first in worker-farmer improvement (superación), followed by a second and a third course, the "basic secondary" (junior high school level).

Lastly, in September, 1962, the «home follow-up circles» were created to attend to the needs of the isolated new readers in the country.

In December, 1962, the first results were already tabulated: 102 710 pupils from the follow-up courses took the final test.

Meanwhile, the post-literacy adult education work was improved and extended with the creation of the second course of worker-farmer improvement and of the third course in April, 1963.

In August, 1963, after the fourth National Congress of Municipal Councils of Education, the follow-up courses were renamed «First Course of Worker-Farmer Improvement» and the home follow-up circles «Home Reading Circles».

Lastly, in December, 1963, on the occasion of the Worker-Farmer Education Teachers' Seminar, not only a recapitulative examination of the numerous seminars, congresses, provincial, municipal and national conferences held was made, but also of the evolution and material organization of worker-farmer education.

The themes of this seminar were examined and debated again in the seminars between January and March of 1964, so that the Ministerial Resolution of March 20, 1964, No. 222/64, contained the final disposition and structure of all facets of worker-farmer education.

2. Worker-Farmer Education Courses

The course system organized by the National Office of Worker-Farmer Education, codified in the Ministerial Resolution of March 20, 1964, is the following:

I) First Course of Worker-Farmer Improvement

The purpose of the course, which in its first stages, i.e. until August, 1963, was ca-

lled «follow-up» course, was to raise the level of the new readers and those persons with low schooling to that of 3rd grade of primary school.

Program: Interpretative reading, writing and elementary arithmetic.

The «Home Reading Circles», previously called «Home Follow-up Circles», correspond to this First Course.

The object of the «circles» is to help the farmer practice and strengthen his reading and writing skills, and improve his knowledge through habitual reading.

II) Second Course of Worker-Farmer Improvement

The purpose of this course is to raise the pupil from 3rd grade level to that of 6th grade, i.e., to finish primary school.

Program: Spanish and Mathematics.

In general, this second course corresponds to 4th, 5th and 6th grade courses.

III) Third Course in Worker-Farmer Improvement

This course is designed for adults with a higher school level or who have passed the top elementary level test (i.e. sixth grade level).

Program: Spanish: Grammar and Composition. Introduction to the study of literature by the reading of selections and complete literary works.

Mathematics: up to linear equations (elementary algebra); elementary geometry and the international metric system.

Science: Elementary course in Biology, Chemistry and Physics.

The programs are accompanied by recommendations of general and particular nature to the teaching personnel («Orientation for

the Seminars). The suggestions are given with an eye in good didactic methods of adult education, and at the same time endowed with lively revolutionary spirit.

It is recommended to the teacher that he take into account the life and surroundings of the pupil, that he base his teaching on the practical problems of life and on the events taking place in the nation, that he pay particular attention to the relation between the subjects and that he set a flexible schedule, as for example, the schedule for the First Course:

Daily activities	Minutes
1. Roll call	5
2. Current Events	20
3. Arithmetic	40
4. Language	50
5. Other class (for example, a Science experiment, a lesson in Cuban geography, current events, etc.)	30
6. Tasks (Commission Reports)	5

	150

(Minimum time allotted: 2½ hours).

3. Organizational Basis of the Courses

The basis of the courses organization in Worker-Farmer Education, is the classroom.

The centers are subdivided into:

1. Non-unified centers including First and Second Course students.
2. Unified centers combining the three level courses.
3. Independent centers in which only third course or secondary level instruction is imparted.

The students are grouped in independent 1st, 2nd and 3rd course classrooms or in mixed classrooms where 1st and 2nd courses are taught.

However, even though the unified center is considered the most adequate basis for worker-farmer education, the greater part of the courses are not given as yet in centers, but rather in independent classrooms.

The information given by the 1963 statistics on the first and second courses is the following:²

Course	Centers	Independent Classrooms
First	550	5 369
Second	1 213	5 075
Mixed Independent	—	5 321

² Source: Boletín Estadístico EOC (Educación Obrera y Campesina), December, 1963.

1. STATISTICS ON THE INCREASE IN THE NUMBER OF COURSES FOR THE YEARS 1962-1963

Worker-Farmer Education in 1962 (National Summary)

Months	Courses (*)	Classrooms	Enrollment	Teachers
March	First	13 123	285 163	13 190
	Second	4 536	102 770	3 527
	Total	16 659	387 934	16 717
July	First	15 012	416 054	14 493
	Second	5 624	128 452	5 242
	Total	20 636	544 506	19 740
November	First	14 743	394 984	14 100
	Second	6 711	143 093	5 210
	Total	21 454	538 076	19 310

* Including the Home Reading Circles and the night schools.

ORGANIZATIONAL DIAGRAM OF THE NATIONAL OFFICE
OF WORKER-FARMER EDUCATION
1964

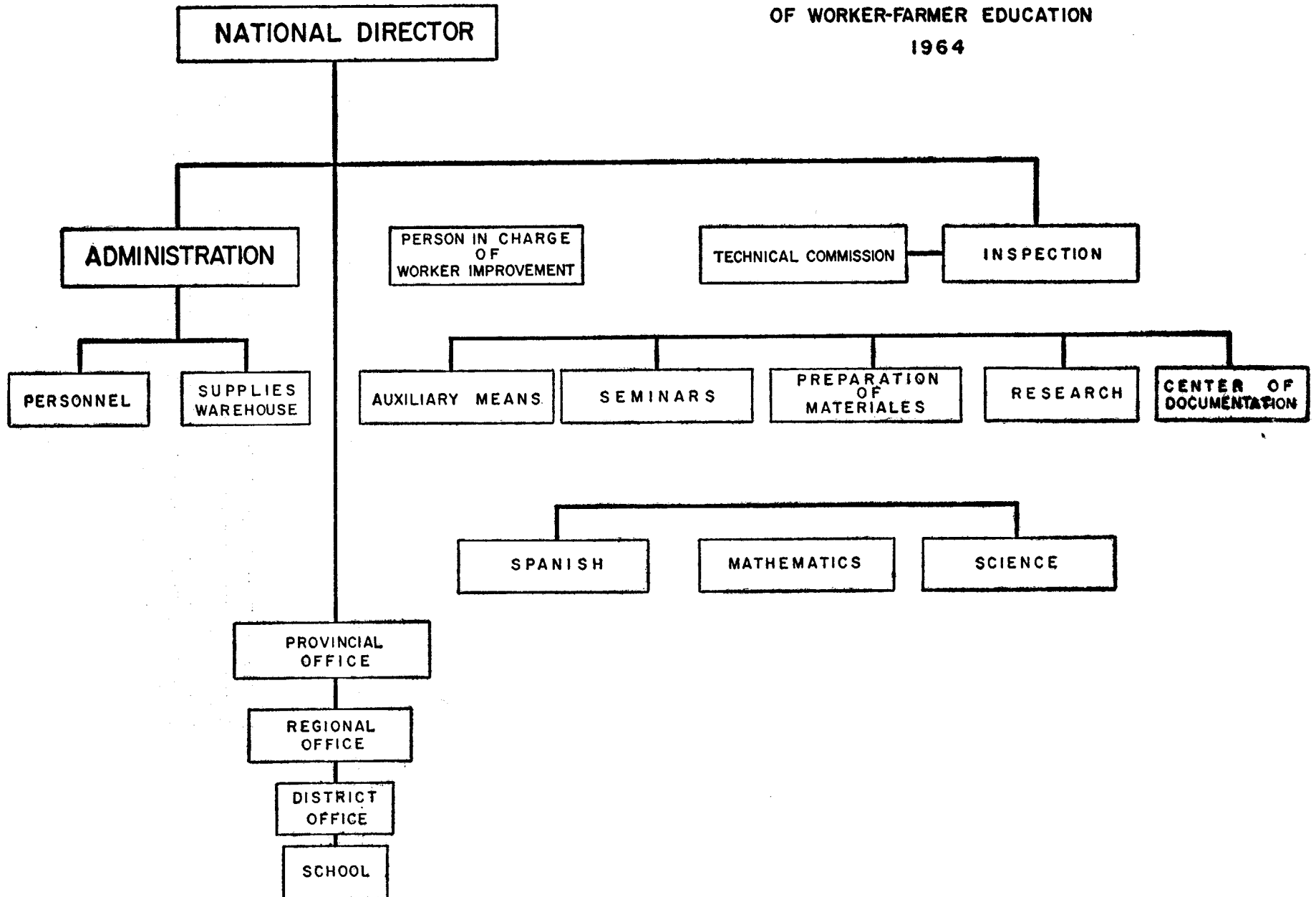

Worker-Farmer Education in 1963 (National Summary)

Months	Courses (*)	Classrooms	Enrollment (**)	Teachers	
				Cert.	Non cert.
April	First	6 221	158 982		
	Second	5 689	135 931		
	Mixed (***)	3 938			
	Third	913	28 951	820	299
	Total	16 761	323 864	820	299
June	First	6 544	168 954	1 271	4 716
	Second	6 109	150 520	2 535	3 072
	Mixed	4 154		1 112	2 818
	Third	965	31 133	779	296
	Total	17 772	350 607	5 697	10 892
November	First	5 919	175 610	925	4 053
	Second	6 288	215 175	2 492	3 592
	Mixed	4 154		904	4 369
	Third	1 054	37 332	863	324
	Total	18 582	428 117	6 184	13 229

It is timely to call special attention to the rapid increase in pupil enrollment in the First Course during the period from March to November, 1962 (beginning with 295 163, reaching a maximum of 416 054 in July, and ending in November with 394 983). It is also interesting to observe that between November, 1962 and April, 1963, came a dramatic reduction of approximately 60% (158 982

enrolled in April), followed by a small but regular increase during the rest of the year.

There has been a constant increase in pupil enrollment in the Second Course, with the evident exception of the small decrease registered between November, 1962 and April, 1963.

The number of pupils enrolled in the Third Course also increased during 1963.

* Including the Home Reading Circles and the night schools.

** Those who attended the mixed classrooms have added to those of the First and Second Courses.

*** Mixed classrooms are those in which the First and Second Courses are taught.

Source: Boletín Estadístico de la Dirección Nacional de Educación Obrera y Campesina.

Source: Boletín Estadístico EOP, diciembre, 1963.

Chapter II

THE WORKER-FARMER EDUCATION STRUCTURE

1. The Worker-Farmer Education Structure

The worker and farmer educational movement operates on three closely linked planes:

a) **A popular plane:** the political and cultural movement represented by the participation of the mass organizations in the education work. They function under the direction of a technical team at each level of the mass organizations in meetings and popular manifestations. From the practical point of view of worker-farmer education, the activist, the guide and the amateur teacher are of great importance.

b) **A mixed plane,** of an organizational and technical nature, inspired by the councils of education at all levels. On this plane the mass organizations representatives as well as those from the State and school administrations, collaborate.

c) **The administrative and technical plane** proper, also present at all levels, and based on the structures of the National Office of Worker-Farmer Education with headquarters at the Ministry of Education of which it is a dependency as is the Primary School Department.

2. Popular Organizational Plane: Mass Organizations

The function of the mass organizations in worker-farmer education and in social promotion, both of which are intended to give the population a sixth grade level is still very important.

Of course, no one would expect, as an everyday occurrence, the superhuman effort

mass organizations made during the Literacy Campaign, but rather the slow, persistent deeds which transform them into meaningful educational instruments. At the close of the Campaign the bases of its structure survived, together with the experience of a popular cultural movement closely integrated, on the one hand, to the political, social and economic circumstances, and on the other, to everyday life and the problems of labor.

In worker-farmer education, we find again the mass organizations which participated in the Literacy Campaign: Confederation of Cuban Workers (C.T.C.), National Union of Workers in Education and Science (SNTEP), Cuban Women's Federation (FMC), National Association of Small Farmers (ANAP), Union of Young Communists (UJC), etc. But the organization par excellence in worker-farmer education is the Committee for the Defense of the Revolution, born, as we have explained, during the Literacy Campaign. In these committees are found numerous members of mass organizations, more advanced and incorporated into revolutionary activities; the political function of said committees is indirect and manifests itself in a whole series of human relations.

A brief description of the work of the Committees for the Defense of the Revolution may give an idea of their function in worker-farmer education. The Committees for Defense embrace close to two million members among an adult population of four million. Each member may also belong to the PURSC or to another organization. The

chart below shows the percentage in membership:

Union of Young Communists	10.3%
C.T.C. (trade union) members	27.6%
Members of National Association of Small farmers (ANAP)	6.5%
U.E.S. (Union of Secondary School Students)	11.1%
Revolutionary National Militia	21.2%

54% of the Committees for Defense membership is male and 46% female, 32% of the latter belongs to the Cuban Women's Federation.

There are at the present time 105 thousand Committees for Defense throughout the country. The objectives of these Committees are multiple. Thanks to their many functions, it is possible to mobilize them for the public health matters, as in the anti-polio campaign and blood donations; or problems in education, such as worker-farmer improvement, primary school, popular libraries, etc.

The Committees for Defense have 2365 educational teams with 27 778 people. Each Committee has a person in charge of education, generally a teacher.

3. The Mixed Plane: Councils of Education

The activities of the mass organizations in educational work are not limited to organization, popular mobilization, publicity and the forming of public opinion, but are also exercised officially through the educational structure, i.e., they assume an institutional character in the Councils of Educational at all levels.

From the National Council down through the provincial, regional and municipal coun-

cils, one arrives at the school councils. The cornerstones of this pyramidal structure are the municipal councils. On the geographic and administrative scale of the municipality, the Municipal Council represents the catalytic and dynamic element between the action of the Council located at the national plane and the action of the Council located at the level of the small primary school or of the adult classrooms.

The Councils are mixed organizations made up of representatives of the mass organizations, trade unions and the teachers and administrators of primary education and worker-farmer education.

The Council is composed of the Executive Staff and the Integrated Plenum. The Executive Staff consists of a President, a General Secretary, a delegate from the Union of Workers in Education and Science, the Union of Secondary School Students, the Union of Young Communists, the Confederation of Workers, the Committees for the Defense of the Revolution, the National Association of Small Farmers, and lastly, the supervisors of primary education and the persons in charge of worker-farmer education. In its turn, the Integrated Plenum is made up of the Executive Staff, the presidents of the classroom councils for each different type of course, the directors, the presidents of the Union of Secondary School Students and the general secretaries of the Union of Young Communists from the various centers of secondary education.

The function of these councils is shown in their very composition; they constitute a bridge, a close link between the technical and administrative structures of education (which are all under the direction of the Ministry of Education) and the people (in regard to the aspect of revolutionary, technical and cultural promotion).

**4. The Administrative and Technical Plans:
The National Office of Worker-Farmer
Education**

The National Office of Worker-Farmer Education orientates and directs the technical and administrative aspects of the three courses in worker-farmer improvement.

The basic task of the National Office consists in preparing the text-books and in organizing the seminars for the training or improvement of the teaching personnel.

There is a special department of the National Office (see the organizational diagram of the National Office of Worker-Farmer Education) which has the responsibility of coordinating and studying the forms of collaboration with the mass organizations and the Councils of Education as well as with the functionaries of the Ministries interested in everything related to the previously determined educational objectives.

Chapter III

BRIEF DESCRIPTION OF THE ORGANIZATIONAL FORMS AND METHODOLOGY

1. Courses I, II and III of Worker-Farmer Education

Courses I and II are meant for those who have just learned how to read and write and those who have fallen back into a state of illiteracy. On the other hand, some reflections should be made in regard to the junior high school level (III Course) and to the Home Reading Circles.

The III Course was not created until 1963, and even today it is in an experimental stage. Its origins are partly in the transformation of the night schools, but its program does not correspond to the parallel course of the regular junior high school. It is just a post-elementary school improvement course for workers and farmers who are conscious of their responsibilities and desirous of raising their cultural level through studying so they may contribute to an increase in their country's production. On a more concrete plane, the secondary course is a preparatory one for the Workers' and Farmers' Colleges and other specialized schools.

2. Home Reading Circles

Within the program, the Home Reading Circles may be considered a variant of the First Course of Worker-Farmer improvement.

These circles were created in the second stage of the organization of Worker-Farmer Education and represent the broadest stage of the post-literacy work, both in the flexibility of their organization and in their adaptation to their surroundings.

With the end of the Campaign and the return of the young brigadistas to their homes, the post-literacy work ran into special psychological difficulties and delicate problems of organization.

In the rural zones, the long distances made it impossible to gather the minimum of 15 pupils, set by the National Office of Worker-Farmer Education, for the First Course. On the other hand, both in the country as well as in the city, the new readers, and most particularly older people who had been taught in their homes by the brigadistas, did not easily accept the idea of attending school and enrolling in a regular course. These difficulties had an unfavorable influence on school enrollment and attendance.

For these reasons, it was decided that the school should visit the home.

As a consequence, under the guidance of an amateur teacher, a **guide**, the residents of a certain zone meet in the home of one of them to improve their reading skills. The important thing is to stimulate the desire and the habit of reading, transforming this activity into an instrument of ideological and cultural development, as the Ministerial Resolution of March, 1953 proposes.

Any person capable of teaching in a barrio or zone may become a guide. In fact, a guide may be anyone in possession of a school certificate, even though it only be that of primary school.

The Municipal Department of Education controls the activities of the guide and takes an interest in his own cultural advancement.

In the Circle, the guide plays an ideological and cultural role, but the work of persuasion as well as questions of the organization of the Circle (the search for premises, the installation of wiring, chairs, blackboards) are the responsibility of a representative of the mass organizations, called an activist.

The activist represents the contribution of the mass organization to the post-literacy work. He is the brigadista of this period, carrying out his activities in the rural zones in which he should also live. He has the responsibility of keeping a close contact with the team of teachers and with the people in the locality. He may organize Circles if it is so authorized by the Office of Worker-Farmer Education in the area. The activist should connect himself primarily with visiting the Circle regularly, encouraging its work and checking attendance.

The Office of Worker-Farmer Education provides the Circles with all the didactic material for the First Course. When a Circle has an excessive enrollment, annex circles may be organized.

3. Characteristic Methodological Forms

The teaching method conceived by the National Office of Worker-Farmer Education, in close collaboration with the mass organizations and the Councils of Education, corresponds, in regards to the teaching of adults, to the didactic and revolutionary criteria which govern the whole educational system in Cuba, and is based on the four essential principles:

1. Teamwork
2. Emulation
3. Improvement
4. Testing

Teamwork: is the grouping of responsibilities carried out by means of the division

of labor. In general, the team is formed by six to ten pupils in the classroom. Within the team, each pupil has a well defined task and a determined responsibility, and must answer to the team for his work. Above all, the team is responsible to the other teams and to the teacher for each one of its members.

Emulation: this element, which in the socialist countries finds a large area of application, assumes new impetus and stimulus in the field of education. Emulation may be individual, allowing the pupil or teacher to make his work a springboard to honors and rewards, but it may also be a collective venture, giving place to fraternal competition between teams of the same classroom, between schools, municipalities, etc., up to the level of national competition.

Emulation may play a role in all sectors of education, for instance, it could stimulate a pupil to obtain first prize in spelling, arithmetic, oral expression, correct pronunciation, etc.

The classroom team constitutes the basic element of emulation, and it should be remembered that each class is divided into various teams.

Improvement: Improvement is individual betterment and collective promotion. As he teaches, the teacher must improve himself by attending meetings and seminars, bettering his teaching methods, broadening his cultural training and acquiring his certificate or a higher degree. Without leaving his job, the worker and farmer attend worker-farmer improvement courses in order to obtain professional qualification and a higher cultural level. In a word, everybody may partake in the march forward which distinguishes Cuban education.

Testing: In worker-farmer education, periodic written tests are given at all levels in order to check results. There are three types

of tests; the progress test, the exploration test and the promotion test.

Of particular importance was the test carried out on a national scale in May, 1963, to determine the average educational level of the Cuban people and check the results of worker-farmer education.

The carrying out of this academic level test required considerable effort and the

mobilization of the mass organizations, the trade unions and the PURSC on a scale which, up to a certain point, recalled the enormous work of the Literacy Campaign.

The majority of the active population, i.e. 1 040 918 persons from 25 trade unions, took the test.

The results of this test were the following:

**EDUCATIONAL LEVEL OF THE ACTIVE POPULATION AFFILIATED
WITH THE TRADE UNIONS, ACCORDING TO THE SCHOOL LEVEL
TEST IN 1963 (IN PERCENTAGES)**

No. Series	Educational level			Total	Higher than 1st Year Secondary
	Grades 1 - 2	Grades 3 - 6	1st Year Secondary		
1. Farmers	76.0	21.0	1.7	98.7	1.3
2. Sugar workers	54.2	33.8	9.0	97.0	3.0
3. Tobacco workers	54.7	32.1	5.4	92.2	7.8
4. Shoe workers	46.4	39.0	5.8	91.2	6.5
5. Construction workers	54.4	32.4	4.2	90.0	9.0
6. Forestry workers	54.6	31.5	4.6	90.7	9.3
7. Transportation workers (land)	45.1	49.2	5.3	90.6	9.4
8. Gastronomic workers	48.2	37.7	4.4	90.3	9.7
9. Maritime and dock workers	52.0	32.9	5.0	89.0	10.1
10. Food workers	50.4	31.5	5.5	87.4	12.0
11. Textile workers	41.8	37.4	5.5	84.7	15.3
12. Miners	49.6	27.9	5.4	82.9	17.2
13. Railroad workers	34.3	37.1	9.9	81.3	18.7
14. Store employees	29.3	39.6	10.6	77.5	22.5
15. Typographers	29.5	36.8	10.3	76.6	23.4
16. Art Industry	34.1	31.0	8.9	74.0	26.0
17. Metallurgy	32.9	32.9	7.8	73.6	26.4
18. Petrochemistry	27.1	32.5	8.7	68.3	31.7
19. Public Administration workers	25.3	26.0	11.5	63.4	36.6
20. Air Transportation workers	20.0	28.2	10.9	59.1	40.9
21. Electric Energy	15.7	29.4	13.6	58.7	41.3
22. Medicine Workers	29.0	22.5	7.0	58.5	41.5
23. Education	30.0	20.0	7.0	57.0	43.0
24. Bank employees	4.7	16.0	23.1	43.8	56.1
25. Telecommunications	6.0	18.6	16.5	41.1	58.9
National percentages	53.0	26.1	5.5	86.6	13.4

The different trade unions have been placed in decreasing order. Thus the first, the Farmers' trade union, has the largest number of persons with a first and second grade education, while the last, the trade union of the telecommunications workers, shows the largest number of persons with

an education higher than that of first year secondary school.

In the teachers union, the relatively high number of persons with only a first and second grade education (30%) is surprising. Probably, this is due to the presence of a large service personnel.

Chapter IV

THE TEACHING PERSONNEL IN WORKER-FARMER EDUCATION

1. The Teachers

There are four categories of teachers in worker-farmer education:

- a) Certified teachers who devote supplementary hours to worker-farmer education.
- b) Vanguard teachers who work with the children's classes in the morning and with adult classes in the evening, in the mountainous and isolated regions.
- c) People's teachers, enabled to teach primary classes after passing emer-

gency seminars, who also work at night in their leisure hours teaching adults.

- d) Amateur teachers, certified and non-certified, who work in teams at night with the help of an adviser.

Practically everybody may participate in worker-farmer education, once they have attended the seminars and accelerated courses in adult teaching.

The distribution of the teaching personnel in worker-farmer education is the following:¹

Course	Professional personnel		Amateur personnel		Total	
	Number	%	Number	%	No.	%
First	1 829	16	9 319	84	11 142	100
Second	2 492	40	3 592	60	6 084	100
Third	863	74	824	28	1 187	100
	<hr/>	<hr/>	<hr/>	<hr/>	<hr/>	<hr/>
	5 184	28	13 229	72	18 413	100

2. The Training of Non-certified Teachers

The team: A group of six to ten teachers from the same area form a team. On a set day of the week, generally on Saturdays, the team meets for several hours or for the entire day in pursuit of the following objectives:

- a) The cultural and technical betterment of each member in order to improve his professional capacity.

- b) His preparation for the following week tasks based on the experience required in the previous week and on the analysis of the Spanish and Arithmetic lessons to be taught.

The other objectives of the weekly team meetings are: The preparation of file cards, discussions about the applicable methods for increasing the enrollment and for insuring the assiduity of the pupils, and the inves-

¹ Source: Boletín Estadístico EOC, diciembre, 1963.

tigation of the possibilities of creating new Home Reading Circles.

There is a person in charge of the team, and the meeting held every week or every two weeks helps in organizing seminars on a municipal or national scale.

Seminars: Seminars are held periodically at all levels, national, provincial and municipal. They constitute the basis for the training and the style of the teachers.

The Ministerial Resolution of March 20, 1964 indicates that improvement of the teaching personnel, organization of the work and emulation will be carried out through seminars, which in their turn, will be the instruments of planning, analysis and evaluation of the results.

Each seminar has two fundamental aspects, the ideological and the technical.

Chapter V

EDUCATION FOR WOMEN

1. General Aims

The educational system instituted in Cuba to favor the rapid evolution of the political and social standing of the woman, is of particular interest.

One of the objectives of the Cuban Revolution is to guarantee the economic, political and social equality of men and women.

The most urgent problem was presented by the menial workers and farm women, who constituted the major part of the women on the island. In order to integrate these women into the industrial and agricultural revolution, it was necessary to improve their cultural and technical education and, besides, to find them a work adapted to their ability, which would free them from economic and social subjection.

2. Department of Schools for Women's Educational Improvement

With this aim in mind, in addition to worker-farmer education, which was organized as well for men as for women, the «School for Women's Educational Improvement» was created in order to face the problem of women in the Cuban society more rapidly and concretely.

The Department has planned its work in various schools, for cultural, technical and professional promotion of women. In addition, many nursery schools were opened to permit mothers to work or study peacefully.

In this Department we find the Courses for the «Comrade Benítez» revolutionary teachers and the Makarenko Pedagogical Institute, i.e. the training schools for teachers to be employed at women's educational improvement schools.

In this Department, the following are of particular importance:

- a) The night school for menial workers, inaugurated in Havana at the end of 1961.

In 1962, there were some 20 000 former domestic servants who attended night classes organized in more than 60 schools in the capital and its surrounding districts. The courses are varied: driving training, typing, commercial secretary, shorthand, administration, etc.

- b) The Ana Betancourt school for farm women, in which some 10 000 young girls (in 1963, there were 9 924) from the rural zones, mainly from Oriente province, are Government scholarship pupils, distributed in all of the provinces, from those far illiterates to the more advanced.

At the same time, the pupils attend classes in Home Economics and Sewing, but the major attention is placed on academic studies, and the best students pass immediately to the study of agricultural technology.

In 1963, the Department of Schools for Women's Educational Improvement carried on the following activities:

- a) Correspondence courses for Revolutionary Teachers
- b) The Makarenko Pedagogical Institute

- c) Evening Schools for Improvement of (former) domestic workers
- d) School for Specialization of (former) domestic workers
- e) Courses for Nursery School Attendants
- f) Ana Betancourt School for Farm Women

Chapter VI

THE LINK BETWEEN WORKER-FARMER EDUCATION, AND TECHNICAL AND PROFESSIONAL TRAINING

1. General Aims

The plan for worker-farmer education and even the whole plan for adult education in Cuba is only one aspect of the four year plan of economic development (1962-1966).

At present, the post-literacy work, in its various forms and as a whole, not only represents the logical and obligatory result of the Campaign, but also answers to the need of linking the educational process to the development of industry.

The pedagogical objectives have an ideological basis, which identifies the aims of a revolutionary policy with two basic questions: the problems of the class struggle and the problems of technical progress.¹

The courses for worker-farmer education are combined with various other courses of technical and professional instruction, which are the responsibility of other centers, as for example, the Ministry of Industry and the National Institute of Agrarian Reform. These Ministries have organized many courses in technology and administration.

Of particular importance for the aims of our study are the courses called «massive courses», which include the three Courses of worker-farmer education, the «Minimum Vocational Courses» and the evening classes of the popular schools, and finally the three courses of the Workers' College.

2. Minimum Vocational Training Courses

The courses of «Minimum Vocational Training» are given in the places of work and

last from 6 to 8 months (in agriculture, the minimum duration is 3 months, since three classes are given weekly). The instructors are higher skilled workers and farmers, who are guided in their task by engineers and technicians.

To the courses of Minimum Vocational Training falls the task of establishing a link between worker-farmer education and the plans for professional training. These courses represent the key, not only to the integration of the newly literate and those with a poor schooling into society and work, but also to all efforts to increase production, to the success of the Agrarian Reform and to the industrialization of Cuba.

In the face of the urgent need of the practical and technical studies for the Minimum Vocational Training, the great problem consists in giving the basic cultural education (Spanish and Arithmetic) a very important place in worker education. Really, there is no incompatibility between the courses in worker-farmer education and the courses in Minimum Vocational Training; on the contrary, it is recommended to the worker and farmer that they attend both.

However, taking into consideration the fact that the worker and farmer have very little time, this double attendance is possible only in theory, especially since they are essentially interested in acquiring a professional qualification which will allow them to advance on the wage scale established by the Ministry of Labor.

¹ Arsenio Haet Dávila, Ministry of Education —Fifth Nation— at Congress of Municipal Councils of Education, August, 1963.

For all these reasons, those persons in charge of the Minimum Vocational Training courses in the Institute of Agrarian Reform are studying the possibility of combining the courses of Minimum Vocational Training and those of worker-farmer education into one which would probably be called «Technical Levelings» and whose objective would be to balance a basic culture, a revolutionary culture and the acquisition of technical knowledge.

3. The People's Schools

These schools have been created for workers who have been left jobless as a consequence of automation and mechanization.

Their objective is to give these workers new qualifications and possibilities for a new job through the acquisition of technical and cultural knowledge.

The teaching is carried out in two stages: the first consists of a course in general culture and the second, of the training for a new job.

4. The Workers' Preparatory College

The Workers' Preparatory College which is directly under the rector of the University, is an evening school where workers are prepared to enter the University. These Colleges are located at Havana, Santa Clara and Santiago de Cuba Universities.

The workers and farmers who do not have a high school diploma can take an examination on the basis of which they are admitted, according to the case, to the first, second or third course. After finishing the third course, they may enter a Science or Technological College.

In theory and in practice, every young person who learned how to read and write during the Campaign, after passing all courses in worker-farmer education at its various levels, may pass the entrance examination of the Workers' Preparatory College, and after studying the three courses there, is entitled to enter certain University courses.

In April, 1964, the enrollment in the Workers' and Farmers' Preparatory College at the University of Havana reached 1259.

CONCLUSIONS

The Literacy Campaign carried out in Cuba constitutes an event typically Cuban, because of the historical and revolutionary circumstances in which it was accomplished.

But, setting aside the particular phenomenon which it represents, the Cuban experience has an indicative value and offers general ideas and examples which can inspire the teaching of reading and writing to adults and adult education.

The Campaign was not a miracle, but rather a difficult conquest obtained through work, technique and organization.

Undoubtedly, the work was sustained by the revolutionary impetus; the success, nevertheless, depended primarily on the organization of the Campaign based, on the one hand, on the interpretation and guidance of the desire of the people for progress and for cultural, technical and social betterment, and on the other, on the integration of worker-farmer education into the economic movement and development.

If the evaluation of this Campaign, which was a great event in the educational field, cannot be set apart from a political evaluation, this is due to the fact that the Campaign was, in itself, a political event. The very results of the Literacy Campaign which were unquestionably positive, cannot be perfectly understood without taking into consideration the social and cultural objectives of the country and the efforts made toward technical and professional promotion, which are required by the industrialization program and the Agrarian Reform in Cuba.

People's participation and a consciousness of the social and economic realities continue to be the basic postulates of all work to abolish illiteracy, aside from the fact that, according to the situation of each country, the

character of the programs and the historic circumstances, this struggle will be carried out in different manners and with different duration of time.

I. Some Observations Concerning the Literacy Campaign

The Cuban Literacy Campaign had three elements in its favor: linguistic unity, density of population and the climate.

Besides, the fact that the Campaign was carried out as it was, without sparing resources, time or human forces, not only makes impossible a calculation of these, but also makes very difficult an evaluation of the vast and multiple possibilities opened by the success of the Campaign.

The Campaign was an organized and thought out movement which transcended its original plans.

For this reason, the Mission must content itself with delimiting the principal characteristics of the Campaign and of post-literacy work in a way so that from these observations may arise more general lessons than those to which we have alluded.

The principal characteristics of the Campaign were three:

1. limitation of the educational efforts to the literacy level
2. horizontal organization through the work of the «alfabetizadores».
3. use of radio and television, limited to publicity and persuasion.

As we have said, the teaching was limited to the rudiments of the reading and writing and arithmetic as the final test shows. In other words, a 1st grade literacy level.

At the National Literacy Congress (Havana, September 25, 1961), Raul Ferrer, National Director of Worker-Farmer Education Department, clearly presented the problem and declared that the duty of every «alfabetizador» was to help the illiterate to understand well the primer.

In this way, he could teach many other persons how to read and write or would be ready to perform other services in the Campaign. The Revolutionary Government was already studying and planning the organization of the campaign of «follow-up and improvements».

If, from a technical point of view, the Campaign was one of providing a 1st grade level in reading and writing, from an organizational point of view it was a «horizontal» event, i.e. decided by the problem of quantity. The Campaign was approached as, and truly was, a problem of the people.

The issue was to reach, in a short time (one year), a technically easy objective (a knowledge of the primer): there remained to be established a horizontal structure which would permit that the greatest number of persons be reached, that the majority of them be taught how to read and write, and that the greatest number of «alfabetizadores» be employed.

The organization was the masterpiece of the Campaign: at the same time it became a better and better organizational structure of and for the Campaign, it also became an instrument of revolutionary integration.

The brigadistas visited the most isolated homes, and the people's «alfabetizadores» systematically returned to the most miserable huts of the outlying districts.

In spite of the fact that in Cuba, radio and television are highly developed and that Fidel Castro put greatest emphasis on winning the battle against illiteracy, it was decided not to use either the radio or television directly or indirectly for this purpose.

On the other hand, these media were used very widely for the purposes of publicity and persuasion.

A plan was discarded, which had called for a three year period for the abolition of illiteracy. This plan had been prepared by some experts in the early days, and was based on the use of radio and television, following the example of other plans prepared in Latin America.

It was possible that the illiterate could wait three years but the Revolution could not.

The secret of the success of the Campaign must be found in a very simple fact, one that is very old and foreign to all technical means: human relationships. It must be found in those intellectual, sentimental and psychological chain reactions, which arise when relations are established between one human being and another.

It is possible that in three years the sought after farmer could have learned how to read and write by means of the radio, television and technical and pedagogical procedures. But he would not have acquired a political consciousness. Thanks to the work of the «alfabetizadores» and the brigadistas, he has learned how to read and has become a revolutionary.

As we have already pointed out, the post-literacy work will begin shortly. This work will take into consideration quality and not quantity. It is precisely the principles of quality, which are represented by this system of rational coordinates that interests itself in man's technical progress, and at the same time in his education. It is a problem as important for Cuba in the present day, as the struggle against illiteracy was in 1961, a problem whose solution, through the work of worker-farmer education, should provide the entire population with a sixth grade educational level.

2. Some Observations Concerning Post-Literacy Adult Education

The post-Campaign period may be used indirectly for evaluating the Campaign proper. Not all of the 707 000 persons who learned how to read and write in the Campaign enrolled in the worker-farmer educational courses, but only 76%, as we have seen. If those enrolled in the 1st and 2nd courses are included—416 054 and 128 462 respectively, i.e., a total of 544 536 persons).

Nevertheless, this percentage is satisfactory, if the initial difficulties are taken into account, as well as those of a more general nature inherent in the transition from the literacy campaign work to that of the post-Campaign period.

In fact, if on the one hand, the objective and the limits of the Campaign, i.e., a 1st grade literacy level, were one of the positive aspects of the Campaign and one of the elements of its success, they constituted, on the other hand, a thorny point of departure for the post-literacy work.

Obviously, worker-farmer education, as a post-literacy activity, was a logical and necessary consequence of the struggle against illiteracy. But starting as it did, after the end of the Campaign, it met with the problem of continuity in regards to the Campaign, i.e., it had to begin anew, in a vacuum (organic and technical) determined by the abolishment of the organic and technical structures of the Campaign.

The fact that Cuba has been able to overcome these difficulties should not lead us to depreciate the dangers which the post-literacy work faces, when the work of teaching how to read and write was not conceived in its beginnings as adult education, a concept which prevents the separation of the acquisition of the instrument and the consciousness of knowledge, as elementary as it may be.

If it is true that with the Campaign ended its organizational structure, it is no less true that the bases of this structure, i.e., the revolutionary impetus and the political orientation, and the complete support of the mass organizations survived. Although modified in their composition, the Councils of Education also survived, and should play a decisive role in the revolutionary administrative and technical structure of Cuban education.

Added to this, there is the close link (so as not to say integration) between worker-farmer education and the four year plan (1962-1966) for economic development, i.e., the close tie with professional and technical education, both in regards to the professional training of the individual and to the consequent salary increases, as well as to the improvement and increase of production in general.

The fact that the technical and political leaders of the Campaign and of the post-Campaign work were conscious of the need of carrying out the literacy work and the post-literacy work in two stages, and the preparation of the «Follow-up» Courses while the Campaign was still in progress, contributed greatly to the elimination of the difficulties.

However, many inconveniences were still encountered, and in this respect, we cite the frank declaration of Raúl Ferrer, Director of Worker-Farmer Education: «As for the new front, and it is just that, worker-farmer education has begun with a series of difficulties which range from a lack of teachers in the rural zones to an insufficiency of books, passing through the search for and the conservation of teaching personnel...» The word «conservation» denounces the second and the gravest difficulty of all the post-literacy work.

The struggle for the abolition of illiteracy may have a limit as in Cuba, but the post-literacy work cannot, or at least, if it does,

it must be much more distant. This is shown by the three basic courses of worker-farmer education.

It is not enough to create and organize educational work, it is also necessary to continue it.

Once the initial difficulties are solved, once the work has begun, the problem of maintaining the teaching personnel does not annul the danger of a paralyzing crisis in the initial impulse.

As those people in charge recognize and the statistics show, this crisis was produced in worker-farmer education between the months of November, 1962 and April, 1963. Not even the reading circles, which may be considered as one of the most open forms of the Cuban post-literacy work, could escape this eclipse after a period of great success. This eclipse caused a fear of gradual failure, but fortunately, was remedied in time. In fact, statistics show that the worker-farmer educational movement is recuperating slowly, but regularly.

Among the valid and concrete motives which have determined this recuperation, the efficient work of the activists should be emphasized. In Playa Larga and Ciénaga de Zapata, the Mission was able to confine

the enormous work of persuasion, of profound penetration and the slow and obvious success, during the period of one year, thanks to the constant presence of a good activist.

Lastly, of particular importance is the problem we have already mentioned in regards to the Minimum Vocational Training courses. In this case, there is an attempt to balance cultural work, indispensable basis for the acquisition of a technique and the professional training proper, indispensable basis for the production improvement and for the economic growth of the country.

Worker-farmer education is an institution too recent to permit an evaluation of more than the pure and simple statistics, which cannot reflect the importance and seriousness of the great educational movement initiated on the island of Cuba.

But the problems which worker-farmer education has had to solve, especially those on a more general plane, more broadly typical of post-literacy work, such as the initial difficulties, the lessening of the impetus and the crisis of conservation and that devoted to technical training and to the practical questions in the course of professional education, constitute in themselves signs of orientation and indicate many other options.

Appendix

Sources:

1. List of the interviews and principal visits made by the Unesco Mission during its stay in Cuba

(In chronological order)

1. Dr. Abel Prieto, Vice-minister of Primary Education.
2. Dr. Isabel Jurado, In charge of Supervision of Worker-Farmer Education.
3. Mr. Raul Ferrer Perez, Director of Worker-Farmer Education and Vice-coordinator of the Literacy Campaign.
4. Dr. Gaspar J. Garcia Gallo, General Secretary of the National Union of Workers in Education and Science.
5. Dr. Consuelo Porta Estrada, Director of Primary Education.
6. Visit to the closing of the Seminar on Optional Subjects in Worker-Farmer Education.
7. Dr. Hector Ferran Tuirac, Director of Teaching Training.
8. Visit to the municipality of Melens del Sur, accompanied by Dr. Isabel Jurado and Dr. Teddy Aguilar Abreu.
9. Dr. Raul Gutierrez, Director of Educational Extension.
10. Dr. Maruja Iglesias, Sub-Director of the National Library.
11. Visit to the National Library.
12. Dr. Maria de los Angeles Perin and the Technical Team of the Literacy Campaign.
13. Dr. Olinta Ariosa, In charge of School Libraries on a national scale.
14. Mr. Jose Matar and Mr. Angel Valiente, Respectively the National Coordinator and the person in charge of the National Office of the Committees for the Defense of the Revolution.
15. Mr. Angel Gutierrez, Training Director of the Ministry of Industry.
16. Dr. Nieves Valmaña, In charge of the archives of the Conrado Benitez Brigade.
17. Dr. Elena Gil, In charge of Women's Educational Improvement.
18. Visits to the Schools for Women's Educational Improvement and the Makarenko Institute.

19. Dr. Carmen Gomez, National Educational Director of the Cuban Women's Federation.
20. Mr. Alejo Carpentier, Director of Editora Nacional.
21. Dr. Ana Maria Cruz Fernandez, Secretary of the National Union of Workers in Education and Science, Technical Adviser of the Literacy Campaign in Havana.
22. Miss Marta Menendez, In charge of Minimum Vocational Training in the National Institute of Agrarian Reform.
23. Dr. Juan Marinello, Cuban Ambassador to the UNESCO and President of the Peace Movement.
24. Visit to the «Angela Landae» Unified Center of Worker-Farmer Education and to the Workers' Preparatory College of the University of Havana.
25. Mr. Mario Diaz, National Coordinator of the Literacy Campaign.
26. Mr. Carlos Herrera, Chief of Public Relations of the Ministry of Education.
27. Mr. Oscar Rego, Press Chief of the Ministry of Education.
28. Mr. Manuel Moro and Miss Milta Muñoz, Second person in charge and Executive member of the National Department of Propaganda of the Literacy Campaign, respectively.
29. Dr. Maria Teresa Freyre, Director of the National Library.
30. Visit to the Teacher Training Center at Topes de Collantes, waited courteously upon by Mr. Marcus Perez, General Director of the Center.
31. Mr. Julio Cesar Prat, In charge of Workers-Farmer Education in Playa Larga.
32. Visits to the Worker-Farmer Education Centers for charcoal makers in Cienaga de Zapata.
33. Mr. Sergio Gonzalez, Director of the Schools of Revolutionary Instruction.
34. Mr. Claudio Suarez, Director of the Books and Records Company of the Ministry of Commerce.
35. Dr. Max Figueras, Director of the Institute of Education Improvement.
36. Dr. Heriberto Alviza, National Technical Director of Worker-Farmer Education.
37. Visit to former camps of the Conrado Benitez Brigades in Varadero.
38. Dr. Armando Hart Davalos, Minister of Education.

II. **Written material:**

1. *Comisión Nacional de Alfabetización. Informe del Ministro de Educación de Cuba sobre lucha contra el analfabetismo y tarea de la sociedad y los estudiantes.* La Habana, 1961.
2. *Comisión Nacional de la UNESCO. Cuba y la Conferencia de Educación y Desarrollo Económico y Social, celebrada en Santiago de Chile del 5 al 19 de marzo de 1962.* La Habana: Editorial Nacional de Cuba, 1962.
3. *Consejos Municipales de Educación. Segundo Congreso. Congreso Nacional de Alfabetización.* La Habana, Imprenta Nacional de Cuba, 1961.
4. ————. ————. — Tercer Congreso. La Habana, s.d. (1962)
5. ————. ————. — Cuarto Congreso. La Habana, s.d. (1963)
6. *Ministerio de Educación. Comisión Nacional para las Memorias de la Campaña de Alfabetización. Memoria de la Campaña de Alfabetización.* La Habana, no publicado, s.d. (1963)
7. ————. ————. *Dirección Nacional de Educación Obrera y Campesina. Control de los trabajadores que pasaron la prueba de escolaridad.* Resumen nacional. La Habana, 1963 (baja suelta).
8. ————. ————. *El seguimiento. Organización y programas.* La Habana: Imprenta Nacional de Cuba, 1962.
9. ————. ————. *El curso secundario de superación obrera. Orientaciones y programas.* La Habana, 1963.
10. ————. ————. *Estadística (Boletines).* La Habana, abril 1962 hasta diciembre 1963.
11. ————. ————. *Informe acerca de la Educación Obrera y Campesina.* La Habana, Ciudad Libertad, octubre 28 de 1963.
12. ————. ————. *La Superación Obrera. Organización y contenido.* La Habana, Imprenta Nacional de Cuba, 1962.
13. ————. ————. *Recuento de un año de trabajo. Año N° II, Boletín N° 6,* La Habana, abril 1963.
14. ————. ————. *Orientaciones para el Curso Secundario de Superación Obrera y Campesina.* La Habana, Editorial del Ministerio de Educación, 1963, en dos folletos.
15. ————. ————. *Orientaciones para los Seminarios. Cursos de Educación Obrera y Campesina.* La Habana, 1963.
16. ————. ————. *Informe Trimestral. Octubre-Diciembre, 1963.*

17. ————. Informe al pueblo de Cuba del resultado de la Campaña Nacional de Alfabetización. La Habana, Publicaciones, 1951.
18. ————. *Viceministro de Enseñanza Elemental*. Resolución Ministerial No. 222/64, La Habana, 1963.
19. ————. SNTCC, Plan de emulación socialista para Educación Obrera y Campesina. La Habana, 1963.
20. ————. ————. Primera Conferencia Nacional de formación y superación docente. Ponencia de Educación Obrera y Campesina. La Habana, Ciudad Escolar Libertad, 14 de agosto de 1964.
21. *Ministerio de Industrias*. *Viceministro para el desarrollo técnico*. Dirección de capacitación. Análisis de los reportes estadísticos sobre los cursos que se dictan en las empresas, correspondientes al mes de noviembre de 1963 (según modelo IP-6).
22. *Ministerio del Trabajo*. Calificador de ocupaciones comunes de los obreros, La Habana, s. d.